



United States Environmental Protection Agency
Office of Wastewater Management
Washington, DC 20460

Oily Bilgewater Separators

CONTENTS

	Page
SECTION 1 INTRODUCTION.....	1
SECTION 2 REGULATION OF OIL IN BILGEWATER DISCHARGE.....	3
SECTION 3 TREATMENT TECHNOLOGIES AND COMPONENTS OF BILGEWATER SEPARATORS	7
3.1 Gravity Oil Water Separators.....	7
3.2 Centrifugal Separators	8
3.3 Polishing Treatment for Bilge Separators.....	8
3.3.1 Absorption and Adsorption.....	9
3.3.2 Biological Treatment	10
3.3.3 Coagulation and Flocculation	11
3.3.4 Flotation	11
3.3.5 Membrane Technologies (Ultrafiltration).....	12
3.4 Residual Generation.....	14
3.5 Oil Content Monitor.....	14
3.6 Space Requirements.....	15
SECTION 4 EFFECTIVENESS OF BILGE SEPARATOR TREATMENT TECHNOLOGIES	17
4.1 Bilge Separator Treatment System A	18
4.2 Bilge Separator Treatment System B.....	18
4.3 Bilge Separator Treatment System C.....	19
4.4 Bilge Separator Treatment System D	19
4.5 Bilge Separator Treatment System E.....	20
4.6 Bilge Separator Treatment System F	20
4.7 Bilge Separator Treatment System G	20
4.8 Bilge Separator Treatment System H	21
4.9 Bilge Separator Treatment System I.....	21
4.10 Bilge Separator Treatment System J.....	21
4.11 Bilge Separator Treatment System K	22
4.12 Bilge Separator Treatment System L.....	22
4.13 Bilge Separator Treatment System M.....	22
4.14 Summary of Bilge Separator Effectiveness	22
4.15 Limitations of Certification Test Data	24
SECTION 5 REFERENCES.....	25
ATTACHMENT A: PUBLISHED LITERATURE FROM VENDOR WEBSITES	
ATTACHMENT B: SUMMARIES OF INFORMATION GATHERED IN TELEPHONE CONVERSATIONS	
ATTACHMENT C: VENDOR SUBMITTED PERFORMANCE DATA	

LIST OF TABLES

	Page
Table 1: Reverse Osmosis Particle Size and Molecular Weight Ranges	12
Table 2: Residuals Generated From Treatment Technologies.....	14
Table 3: Performance of Bilge Separator Treatment System on Three Commercial Vessels	18
Table 4: Effluent Oil Concentrations for Bilge Treatment Systems.....	23

LIST OF FIGURES

	Page
Figure 1: Footprint Required for Various Bilge Separator Treatment Systems	16

EXECUTIVE SUMMARY

Oily wastes and waste oils are byproducts of operating ocean-going vessels, which generate millions of tons of such wastes annually. Oily bilgewater is the mixture of water, oily fluids, lubricants and grease, cleaning fluids and other wastes that accumulate in the lowest part of a vessel from a variety of sources including engines (and other parts of the propulsion system), piping, and other mechanical and operational sources found throughout the machinery spaces of a vessel. Bilge spaces are periodically pumped out, and the accumulated bilgewater is transferred into a holding tank. The bilgewater then can be managed by either retaining it onboard in the holding tank and later discharging it to a reception facility on shore, or treating it onboard with a bilge separator. Bilge separators, also known as oily water separators (OWS), are onboard treatment systems designed to remove the oil from vessel bilgewater prior to its discharge. Bilge separator technologies have advanced in recent years to improve the effectiveness of oily bilgewater treatment.

Current regulations of oily bilgewater discharge from vessels is based on Annex I of the *International Convention for the Prevention of Pollution From Ships, 1973* as modified by the Protocol of 1978 (MARPOL 73/78). Under MARPOL, all ships over 400 gross tons (GT) are required to have equipment installed onboard that limits the discharge of oil into the oceans to 15 ppm when a ship is en route. All vessels over 400 GT are also required to have an oil content monitor (OCM), including a bilge alarm, integrated into the piping system to detect whether the treated bilgewater that is being discharged from the bilge separator meets the discharge requirements. Canada has bilge discharge requirements that are more strict than the international 15 ppm standard. The *Canadian Regulations for the Prevention of Pollution from Ships and for Dangerous Chemicals* requires 5 ppm bilge alarms on the Great Lakes.

EPA's 2008 *Vessel General Permit for Discharges Incidental to the Normal Operation of Vessels* (VGP) also addresses discharges of oil, including oily mixtures, from ships subject to MARPOL. Such discharges must have concentrations of oil less than 15 ppm. The VGP also includes technology-based effluent limits and related requirements for specific discharge categories, including bilgewater discharges.

Bilge separators, oil content meters and bilge alarms are certified by the U.S. Coast Guard to meet 46 CFR 162, which implements MARPOL Annex I regulations in the U.S. More than one hundred bilge separators have been certified by the U.S. Coast Guard to meet the MARPOL 15 ppm oil discharge standard. All of these bilge separators are treatment systems that combine a gravity oil-water separator (OWS) or centrifuge with one or more additional unit operations that "polish" the bilgewater effluent to reduce concentrations of emulsified oil. Unit operations that are added to OWS/centrifuge-based bilge separator systems include:

- Absorption and Adsorption,
- Biological Treatment,
- Coagulation and Flocculation,
- Flotation, and
- Ultrafiltration .

EPA evaluated the effectiveness of bilge separators by their ability to achieve low effluent oil concentrations. Certification test data demonstrate that different bilge separators can

achieve 15 ppm and a number of these systems achieved effluent hydrocarbon concentrations below 5 ppm under controlled conditions. Information about bilge separator treatment systems and certification test data was gathered from a number of vendors. This information illustrates that bilge separator treatment systems, based on different treatment technologies and combinations of unit operations, can achieve and exceed compliance with the U.S. Coast Guard certification standards.

Conversely, some type-certified bilge separators have difficulty meeting the 15 ppm MARPOL discharge standard onboard vessels. Some treatment technologies appear to perform better than others at sea, for example better able to handle the rolling and pitching motion, variable bilgewater composition, and periodic solids loading. Certain treatment technologies appear to require excessive operator attention and/or maintenance to function properly, or generate excessive quantities of oily residuals requiring handling and disposal. The laboratory certification tests for these pollution control equipment (i.e., bilge separators, oil content meters, and bilge alarms) may not be comprehensive enough to reveal these shortcomings.

Bilge separator manufacturers and vendors, as well as major shipping companies, indicated that there is an increase in the level of effort required to meet a 5 ppm oil standard versus 15 ppm in bilgewater discharges. Vessels that install certified bilge separators currently on the market, and operate and maintain them conscientiously, should be able to meet a 15 ppm discharge standard, notwithstanding the possible difficulties noted above. Meeting 5 ppm oil standards for bilge discharge is also possible, although it requires an additional commitment to acquiring and maintaining effective bilge separators and OCMs, along with adhering to “best practices” and guidance such as the International Maritime Organization/Marine Environment Protection Committee (IMO/MEPC) *Integrated Bilgewater Treatment System (IBTS)* practices (IMO/MEPC, 2008).

SECTION 1 INTRODUCTION

Oily wastes and waste oils are byproducts of operating ocean-going vessels, which generate millions of tons of such wastes annually (Karakulski et al., 1995). Oily bilgewater is the mixture of water, oily fluids, lubricants and grease, cleaning fluids and other wastes that accumulate in the lowest part of a vessel from a variety of sources including engines (and other parts of the propulsion system), piping, and other mechanical and operational sources found throughout the machinery spaces of a vessel (EPA, 2008). Most of these wastes are generated in the vessel's engine room and end up in the bilge. The types of fluids leaked from these sources varies, resulting in a complex mixture of fluids in the vessel's bilge. Bilgewater may typically contain various fuels, greases, antifreeze, hydraulic fluids, cleaning and degreasing solvents, detergents, metals, catalytic fines, soot, and other solid particles (EPA, 2008). The composition and physical-chemical characteristics of bilgewater can vary widely, both over time and among vessels. Oil/hydrocarbon concentrations in vessel bilges commonly fall in the 100 to 400 ppm¹ range (U.S. Navy 1999-2000). Ghidossi et al., (2009) reported a somewhat higher 500 ppm oil concentration in the bilgewater of a ferry.

Aside from oil and hydrocarbons, bilgewater contains a variety of other pollutants. These include "classical" pollutants (oxygen-consuming parameters, suspended solids), metals (arsenic, copper, cadmium, chromium, lead, mercury, selenium and zinc) and organics (benzene, chloroform, hexachlorocyclohexane isomers, ethyl benzene, heptachlor, heptachlor epoxide, naphthalene, phenols, phthalate esters, toluene, trichlorobenzene, trichloroethane, and xylene) (EPA, 1999). In EPA's recent report to Congress on the *Study of Discharges Incidental to Normal Operation of Commercial Fishing Vessels and Other Non Recreational Vessels less than 79 feet* (EPA, 2010), a comprehensive analysis was made of bilgewater discharges from small commercial vessels including fishing vessels, tow/salvage vessels, water taxis, and tour vessels. Among the metals detected in bilgewater, dissolved copper, selenium, and zinc, as well as total arsenic, were consistently measured at concentrations exceeding the most stringent National Recommended Water Quality Criteria (NRWQC) from several vessel classes. The classical pollutants BOD₅, sulfide, TSS, and TRC were found at potentially significant concentrations in bilgewater from fishing vessels, tow/salvage vessels, water taxis, and tour vessels. Among several pathogen indicators, enterococcus was present at concentrations exceeding NRWQC in bilgewater samples collected from fishing boats. Total phosphorus exceeded a screening benchmark for nutrients. Concentrations of the semivolatile organic chemical (SVOC) bis (2-ethylhexyl) phthalate exceeded NRWQC in the bilgewater discharges of fishing vessels, tow/salvage vessels, water taxis, and tour vessels. Benzene sampled in bilgewater from tow/salvage vessels was the only VOC found at concentrations exceeding the most stringent NRWQC, while the screening benchmark for nonylphenol was exceeded in a single bilgewater sample collected from a fishing vessel. However, EPA believes that the design, construction, and operation of larger vessels not sampled for that study (e.g., cruise ships, ferries, barges, freighters

¹ Concentrations of oil in bilgewater are measured by several analytical methods. EPA Method 1664A measures oil and grease as hexane extractable material (HEM) and petroleum hydrocarbons specifically as silica-gel treated hexane extractable material (SGT-HEM). The method detection limit for HEM is 1.4 mg/L and the minimum quantitation level is 5 mg/L. The older EPA Method 418.1 measures total petroleum hydrocarbons (TPH) using different methods of solvent extraction and quantification. Consequently, the results of samples analyzed with the different methods may not be directly comparable. However, they both indicate whether oil and grease (i.e., hydrocarbons) are present in a sample of bilgewater.

and tankers) differs considerably from that of smaller vessels that were sampled, which could result in significantly different bilgewater characteristics. Hence, EPA cautions against applying the limited bilgewater results from that study to all vessels subject to the VGP.

It is necessary to periodically pump out the bilge spaces into a holding tank to maintain vessel stability and eliminate potentially hazardous conditions from the accumulation of bilge waste (EPA, 2008). The bilgewater then can be managed by either retaining it onboard in the holding tank and later discharging it to a reception facility on shore, or treating it onboard with a bilge separator. Treatment reduces the volume of oily bilgewater that must be stored aboard the vessel. The treated bilgewater then can be discharged overboard in accordance with applicable standards and regulations, while the petroleum products extracted by the bilge separator (i.e., oily waste) are retained in a dedicated holding tank onboard (and later could be incinerated and/or off-loaded in port).

Oil can be found in bilgewater in several forms: free, dispersed and emulsified (Cheryan and Rajagopalan, 1998). The differences are based primarily on the size of oil droplets. In an oil-water mixture, free oil is characterized by droplet sizes greater than 150 μm . Dispersed oil has a size range of 20-150 μm and emulsified oil droplets are typically smaller than 20 μm . The form of oil present in bilgewater is important in determining the effectiveness of treatment.

Traditionally, ocean-going ships use OWS gravity separation devices to treat oily bilgewater. However, OWS separators generally cannot comply with increasingly stringent regulation of oily bilgewater discharge and the greater difficulty of separating oil from bilgewater in modern vessels. Consequently, the effectiveness of oily bilgewater treatments has improved beyond that provided by traditional OWS. Bilge separators that meet current U.S. and international regulations (discussed below) are all treatment systems comprised of a series of unit operations. These systems also incorporate an effluent OCM, an alarm and an automated shut-off designed to prevent the discharge of bilgewater exceeding discharge standards for oil.

SECTION 2

REGULATION OF OIL IN BILGEWATER DISCHARGE

Current regulations of oily bilgewater discharge from vessels are based on Annex I of the *International Convention for the Prevention of Pollution from Ships, 1973 as modified by the Protocol of 1978* (MARPOL 73/78). MARPOL aimed to minimize pollution of the seas, including dumping, oil and exhaust pollution. The United States ratified MARPOL Annex I in 1983. One hundred fifty countries, representing greater than 98% of the world's shipping tonnage, are parties to the Convention. MARPOL includes six annexes, covering six categories of vessel discharges: oil (Annex I), noxious liquid substances (Annex II), harmful packaged substances (Annex III), sewage (Annex IV), garbage (Annex V), and air emissions (Annex VI). Annex I establishes requirements for the control of oil pollution from vessels and applies to all ships operating in the marine environment, unless expressly provided otherwise. Small to large amounts of oil can be found in numerous vessel discharges, including bilgewater, deck runoff, and engine effluent. The requirements of this Annex apply. Specific to machinery spaces, Annex I requirements cover all petroleum products, including crude oil, fuel oil, oily waste, oily mixtures located in the bilge, and petroleum products in cargo spaces of oil tankers.

Under MARPOL, all ships over 400 gross tons are required to have equipment installed onboard that limits the discharge of oil into the oceans to 15 ppm when a ship is en route.² However, the limit for discharge into special areas differs by vessel type and size.³ Such ship equipment allows for compliance with both international regulations (MARPOL) and U.S. Coast Guard regulations that require the oil content of the discharged effluent to be less than 15 ppm and that it not leave a visible sheen on the surface of the water. Regulations also require that all oil or oil residues that cannot be discharged in compliance with these regulations be retained onboard or discharged to a reception facility.

In 1992, during its 33rd session, the International Maritime Organization (IMO) Marine Environment Protection Committee adopted a resolution, MEPC.60(33), containing guidelines and specifications for pollution prevention equipment for machinery space bilges of ships. In 2003, recognizing the advancement of technology since 1992, the Committee adopted resolution MEPC.107(49), which contained new guidelines and specifications that superseded those adopted in 1992. MEPC.107(49) changed the fluids used to test pollution prevention equipment so they would more closely represent the bilge wastes encountered on vessels. Test fluid "C", which contains a surfactant chemical, emulsified oil and fine particulates, was added as a more realistic synthetic bilgewater. Under MEPC.107(49), the bilge separator must be capable of separating the oil from this emulsion to produce an effluent with an oil content not exceeding 15 ppm. MEPC.107(49) also requires that the OCM record data and time, oil content and operating status, and save this information for 18 months (i.e., Oil Record Book regulations).

² Ocean-going vessels less than 400 gross tons are not required to have the equipment onboard if they have the capacity to retain onboard all oily mixtures and can discharge these oily mixtures to a reception facility (33 CFR 155.350). Certain vessels in this category that embark on international voyages, however, are required to have an International Pollution Prevention Certificate (IOPP) that requires them to have pollution prevention equipment onboard.

³ A ship of 400 gross tons or over and any oil tanker may not discharge oil or oily mixture within a special area. In the Antarctic area, discharge into the sea of oil or oily mixture from any ship is prohibited. A ship of less than 400 gross tons other than an oil tanker may not discharge oil or oily mixture within a special area, unless the oil content of the effluent without dilution does not exceed 15 ppm (MARPOL 73/78 Annex I).

The *Act to Prevent Pollution from Ships* (APPS; 33 U.S.C. § 1901 et seq.) is the federal law primarily implementing those provisions of MARPOL that have been ratified by the United States. With respect to implementation of Annex I, APPS applies to all U.S. flagged ships anywhere in the world, and to all foreign-flagged vessels operating in the navigable waters of the United States. Violations of APPS or MARPOL may lead to detention of the vessel in port, denial of port entry, or the initiation of civil or criminal enforcement proceedings.

The U.S. Coast Guard generally has the primary responsibility to prescribe and enforce the regulations necessary to implement APPS in the United States. The U.S. Coast Guard's requirements for oil discharges from ships other than oil tankers⁴ are very similar to Annex I's requirements. U.S. Coast Guard regulations (33 CFR 151.10) provide that, when within 12 nautical miles of the nearest land, any discharge of oil or oily mixtures into the sea from a ship is prohibited except when all of the following conditions are satisfied:

- The oil or oily mixture does not originate from cargo pump room bilges;
- The oil or oily mixture is not mixed with oil cargo residues;
- The oil content of the effluent without dilution does not exceed 15 ppm;
- The ship has in operation oily-water separating equipment, a bilge monitor, bilge alarm, or combination thereof, as required by Part 155 Subpart B; and
- The oily-water separating equipment is equipped with a U.S. government- or IMO type-approved 15 ppm bilge alarm.

When vessels are proceeding en route more than 12 nm from the nearest land (and not within a special area), the conditions allowing for bilgewater discharge according to the U.S. Coast Guard regulations are somewhat different. Most notably, the last condition from above (oily-water separating equipment is equipped with a U.S.- or IMO-approved 15 ppm bilge alarm) is not included. The regulations still require the ship to operate oily-water separating equipment, a bilge monitor, bilge alarm (or combination), and the undiluted oil content of the bilgewater effluent must still be less than 15 ppm.

EPA's 2008 *Vessel General Permit for Discharges Incidental to the Normal Operation of Vessels* (VGP) also addresses discharges of oil, including oily mixtures, from ships subject to MARPOL. For example, discharges must have concentrations of oil less than 15 ppm. The 2008 VGP also includes technology-based effluent limits and related requirements for specific discharge categories, including bilgewater discharges. These requirements include the following:

- Vessel operators may not use dispersants, detergents, emulsifiers, chemicals or other substances to remove the appearance of a visible sheen in their bilgewater discharges.
- Except in the case of flocculants or other required additives (excluding any dispersants or surfactants) used to enhance oil/water separation during processing (after bilgewater has been removed from the bilge), vessel operators may not add substances that drain to the bilge that are not produced in the normal operation of a vessel.
- All vessels must minimize the discharge of bilgewater into waters subject to this permit. This can be done by minimizing the production of bilgewater, disposing of bilgewater on shore where adequate facilities exist, or discharging into waters not

⁴The requirements for oil tankers are found in a separate section of the regulations (33 CFR Part 157).

subject to this permit (i.e., more than 3 nautical miles (nm) from shore) for vessels that regularly travel into such waters.

- Vessels greater than 400 gross tons shall not discharge untreated oily bilgewater into waters subject to this permit.
- Vessels greater than 400 gross tons that regularly sail outside the territorial sea (at least once per month) shall not discharge treated bilgewater within 1 nm of shore if technologically feasible.

Bilge separators, oil content meters and bilge alarms are certified by the U.S. Coast Guard to meet 46 CFR 162 (implementing MARPOL Annex I regulations). Type approval is based on testing of manufacturer-supplied oil pollution control equipment by an independent laboratory, in accordance with test conditions prescribed by the U.S. Coast Guard (33 CFR 155 and 157 and 46 CFR 162). In conformance with IMO resolution MEPC.108(49), the analysis of oil (petroleum products or hydrocarbon, HC) in bilge separator effluent must be by ISO method 9377-2:20005 or equivalent.

Some countries have bilge discharge requirements that are more stringent than the international 15 ppm standard. MARPOL identifies “special areas” which are considered so vulnerable to pollution by oil that oil discharges within them have been completely prohibited, with minor and well-defined exceptions. The 1973 Convention identified the Mediterranean Sea, the Black Sea, and the Baltic Sea, the Red Sea and the Gulfs area as special areas.

The *Canadian Regulations for the Prevention of Pollution from Ships and for Dangerous Chemicals* requires 5 ppm bilge alarms on inland waters⁶ (Great Lakes), and the Canadian Arctic Waters Pollution Prevention Act requires zero discharge in Arctic waters (all Canadian waters north of 60°). Per personal contact with P. Topping of Transport Canada, when Canada first introduced the 5 ppm option in their regulations, it included the requirement for vessels on inland waters to have approved 5 ppm oil filtering equipment as well as a 5 ppm oil content meter and alarm (see Attachment B). This requirement was found to be unworkable, however, because foreign administrations were approving only 15 ppm oil filtering equipment. Canada issues Certificates of Type Approval for bilge alarms that meet the 5 ppm performance standard.

A number of manufacturers of bilge separators anticipate that a 5 ppm bilgewater oil discharge standard may become more common and widespread in the future. Now, Lloyd’s Register Clean Shipping Index Verification provides a verification service to ship owners and operators wishing to demonstrate their success in reducing the environmental impact of their activities beyond current requirements of classification or statutory rules and regulations,

⁵ This analytical method is “Water quality -- Determination of hydrocarbon oil index -- Part 2: Method using solvent extraction and gas chromatography”.

⁶ Part 2, Subdivision 4 (Oil and Oily Mixture Discharges) of the Regulations for the Prevention of Pollution from Ships and for Dangerous Chemicals states the following under Authorized Discharge — Section I Waters:

The discharge of an oily mixture from machinery spaces is authorized from any ship in Section I waters if

(c) the discharge is processed through oil filtering equipment that

(i) produces an undiluted effluent that has an oil content of no more than 15 ppm, and

(ii) triggers an alarm and a discharge-stopping device as soon as the oil content in the effluent exceeds

(A) 5 ppm, where discharged in inland waters of Canada, or

(B) 15 ppm, where discharged in fishing zone 1, 2 or 3 or in those internal waters of Canada that do not include inland waters of Canada; (end of citation)

including verification of bilgewater treatment systems meeting a 5 ppm discharge standard. The verification service is approved by the Clean Shipping Project, the organization that developed the Clean Shipping Index. More than 1,000 ships have been entered into their Clean Shipping Index database. The Index is a tool that takes into account significant environmental impacts of shipping, such as emissions to air and water, use of chemicals, effects of antifouling, etc. The index is used to identify ships or shipping companies in a database according to the aspects that are most relevant to the user.

Det Norske Veritas (DNV) of Norway requires bilge separators to be equipped with a 5 ppm bilge alarm to fulfill the DNV Guidance for Clean Design (DNV, 2005). These are a set of rules that state requirements for design of equipment reducing the environmental impact from emissions to air, discharges to sea, and deliveries to shore from ships. The requirements are in compliance with or more extensive than those found in international standards currently in force. The rules aim at attaining a ship with controlled environmental standards of design and performance. Compliance with the rules is verified through inspection, measurements and sampling of defined environmental parameters in accordance with the requirements of the rules and in compliance with identified standards and guidelines. The class notation Clean Design identifies additional requirements for controlling and limiting operational emissions and discharges. In addition, this notation specifies design requirements for protection against accidents and for limiting their consequences.

SECTION 3

TREATMENT TECHNOLOGIES AND COMPONENTS OF BILGEWATER SEPARATORS

3.1 GRAVITY OIL WATER SEPARATORS

Traditionally, many ocean-going ships have used gravity OWS separation devices to treat oily bilgewater. Gravity OWS use parallel plate or filter coalescing technologies to separate oil from water by using the different specific gravities of the two liquids and their immiscibility with each other. Bilgewater is commonly heated to approximately 120° F (or higher) prior to OWS treatment because this improves the separation of oil. The OWS contains a coalescing material, which is typically polypropylene, an oleophilic polymer, that may be in the form of parallel plates or loose packed media. Free and dispersed oil droplets in the bilgewater adhere to the coalescing material as it passes through the OWS. These droplets continue to coalesce and then break free from the plates or media and rise to the surface of the OWS tank. The OWS contains sensors that detect the presence of oil and trigger the OWS to automatically pump the collected oil to a waste oil tank.

Gravity OWS can be effective when discrete phases of oil and water are present (Koss, 1996). Studies conducted in the 1970s and early 1980s by the U.S. Navy and others demonstrated that conventional parallel plate gravity OWS could reduce effluent oil concentrations to 20-100 ppm, if care was taken not to mechanically emulsify the oil in the bilge (Noyes, 1993). However, the mixture of fluids accumulating in a vessel bilge can be difficult to separate and often contain emulsified oil (i.e., oil droplets smaller than 20 μm). These emulsions are created through the presence of chemical emulsifiers such as cleaning agents and solvents, and by mechanical means such as transfer system pumps and the vessel's motion at sea. Gravity OWS is not intended to separate emulsified oils from water. When emulsification occurs, buoyancy differences are too small to be exploited in conventional gravity OWS technology. If the suspended particles or droplets have effectively neutral buoyancy, gravity OWS ceases to be effective. Additionally gravity OWS's are ineffective in removing colloidal metals and soluble compounds. Some other bilge contaminants, notably aqueous film-forming foam (AFFF) fire-fighting agents, have also been singled out as adversely affecting gravity OWS performance (Koss, 1996). Newer ships also typically have drier bilges, which reduces dilution and results in higher concentrations of oil, detergent and chemical wastes in the bilgewater.

For the reasons cited above, gravity OWS separation devices typically cannot meet the 15 ppm standard for treatment of oily bilgewater. Performance tests of parallel plate and coalescing bead gravity OWS onboard Military Sealift Command (MSC) ships have shown bilgewater effluent oil concentrations frequently exceeding 15 ppm (Caplan et al., 2000). For example, ERG documented an average gravity OWS effluent oil concentration of 42 ppm based on sampling of five Navy vessels (ERG, 2004)⁷. Maritime organizations in the U.S. and other nations have encountered similar problems with the efficiency, reliability and maintenance of gravity OWS equipment. These organizations are often forced to spend large amounts of money to off-load oil-contaminated water to shore-based facilities for fear of a spill violation. In some cases,

⁷ The OCMs/bilge alarms on these vessels were set to prevent discharge of bilgewater effluents with oil contents exceeding 15 ppm.

discharges of oil-contaminated water has occurred, leading to environmental damage and, in some cases, legal action against crew members, the vessel's operating company, and owners (Penny and Suominen-Yeh, 2006).

3.2 CENTRIFUGAL SEPARATORS

A number of certified bilge separators use centrifuges instead of gravity OWS, also with one or more additional polishing unit operations. Centrifugal separators, like gravity OWS, employ the difference in density between oil and water and coalescence of oil droplets to separate oil from bilgewater. However, they do so by greatly multiplying gravity using centrifugal acceleration. In addition, high centrifugal force can mechanically induce flocculation and coagulation to separate emulsified oil. Centrifuges are demonstrated for treatment onboard vessels, having been used for decades for heavy fuel and lube oil cleaning (see Attachment A). They have also been demonstrated to be an efficient and reliable method for separating oil from bilgewater. Compared to conventional gravity OWS, centrifugal separators are compact and highly efficient, do not require large bilgewater holding tanks and generate minimal waste volume. They run continuously without significant man-hours for operation and supervision and handle varying bilgewater composition, solids loading and oil content, as well as the rolling and pitching motion of the ship. Because they are more efficient than gravity OWS, centrifuges reduce the loading of oil to subsequent (polishing) treatment stages, thereby potentially lengthening the service life of the polisher. Centrifuges use large horsepower motors that require regular maintenance. The initial capital outlay for centrifuges is relatively high. Although more effective than a gravity OWS, the effluent from a centrifuge may still require further treatment to meet discharge limits lower than 15 ppm under all conditions.

3.3 POLISHING TREATMENT FOR BILGE SEPARATORS

Due to the difficulty in removing oil from bilgewater by gravity OWS alone, additional treatment stages (unit operations) are added to bilge separators in order to sufficiently clean and “polish” bilgewater to comply with current and anticipated vessel discharge standards (Sun et al., 2009; Caplan et al., 2000). In addition to providing greater overall reduction in bilge oil concentrations, the addition of treatment stages makes bilge separators more reliable by providing some redundancy to withstand problems or failure of individual stages. Including one or more polishing steps is an added cost to the operation of a ship; however, onboard bilge separation is typically more economical than holding all oily bilgewater for transfer and subsequent treatment on shore (Ghidossi et al., 2009).

More than one hundred bilge separators have been certified by the U.S. Coast Guard to meet the MARPOL 15 ppm oil discharge standard.⁸ All of these bilge separators are treatment systems that combine a gravity OWS (or centrifuge, as noted below) with one or more additional unit operations that polish the bilgewater effluent. Most certified bilge separators combine several post-gravity OWS/centrifuge unit operations such as:

- Absorption and Adsorption
- Biological Treatment

⁸ 124 records were returned from a search of “Oil pollution prevention equipment – 162.050” on the US Coast Guard’s Maritime Information Exchange (<http://cgmix.uscg.mil/Equipment/EquipmentSearch.aspx>, updated Tuesday, August 10, 2010)

- Coagulation and Flocculation
- Flotation
- Membrane Technologies (ultrafiltration)

Descriptions of these unit operations are provided below. These technologies can all be considered post-OWS polishers, as gravity OWS (or centrifuge) treatment is a typical first step for bulk removal of non-aqueous phase components. Although this document focuses on the capabilities and performance of these unit operations to remove oil, these technologies are also capable of removing other pollutants (e.g., suspended solids, metals, organic chemicals) from bilgewater. For example, Tomaszewska et al. (2005) found that ultrafiltration was effective in removing turbidity and suspended solids, organic carbon, and several trace metals (Al, Fe and Zn) from bilgewater, in addition to oil. According to a manufacturer, unit operations are optimized for removal of oil when used in bilge separators, which may reduce their effectiveness in treating other pollutants (see Attachment B).

3.3.1 Absorption and Adsorption

Absorption and adsorption are both physicochemical sorption processes that can be used to separate oil from bilgewater. *Absorption* is the incorporation of a substance from one physical state into another physical state (e.g., a liquid absorbed by a solid). *Adsorption* is the physical adherence or bonding of molecules onto the surface of another phase (e.g., reagents adsorbed from water onto a solid surface). For both processes, bilgewater is pumped through the sorption media in a reactor vessel or contactor, and the oil is removed from the media. Once the capacity of the sorption media is exhausted, the reactor or contactor is removed from service, and the media is replaced. For all sorption processes, the spent media is an oily solid waste residual. Certain spent media can be regenerated aboard ship while others may be regenerated or disposed of on shore.

Oil can be absorbed from bilgewater using granular substrates and absorbents or cartridge filters with surfaces modified to have a high affinity for emulsified droplets (Alper, 2003). Two such modified surfaces used to absorb emulsified oil are organoclay and curable polymeric surfactant (PS). Organoclay is widely used to absorb oil from water. When bentonite or other clays and zeolites are organically modified with quaternary amines, they become organophilic (Alther, 1995). This property of the surface of modified clays enables them to remove oil and other organic compounds of low polarity. When organoclays are placed into water containing mechanically emulsified oil, greases and large chlorinated hydrocarbons, the organophilic clay will remove these compounds by a partitioning process. Therefore, organoclay can be used to remove emulsified oil and grease and other sparingly soluble organics. Disposal options for spent media are cement kilns, landfills, bioremediation through land farming, cement encapsulation or incineration. Based on personal communication with the manufacturer, the usage rate for organoclay is typically about 10 kg/100 m³ of oily bilgewater treated (see Attachment B).

Curable PS is an oleophilic compound that is infused in standard filter materials such as polypropylene fabric. Once cured, the properties of PS are transferred into the substrate, thereby greatly enhancing its ability to attach organic compounds to the filter substrate (Alper, 2003). PS technology works by chemically immobilizing the pollutants into the filter matrix. According to personal communication with the manufacturer, usage rates for PS absorbers are based on replacement of the filters 3-4 times per year (see Attachment B). PS absorbers have affinity for

organic compounds and do not develop additional differential pressure in the presence of very thick oils or under high loading conditions. This property enables PS to capture concentrated slugs of oil without clogging, making them useful as pre-filters for more sensitive and therefore easily fouled filtration methods.

A number of bilge separator treatment systems use adsorption. Granular activated carbon (GAC) is the most popular adsorption media and can effectively remove dissolved oil and hydrophobic organic chemicals from water. Initial capital costs for GAC adsorbers are relatively low. However, based on personal communication with a manufacturer, activated carbon has a low capacity for emulsified oil (5–7 times less than organoclay; Alther, 1995) and becomes saturated once it adsorbs 10-20% oil by weight (see Attachment B). GAC is vulnerable to high suspended solids and oil loading; these can foul or bind the adsorber and require frequent backwashing or media replacement.⁹ In this situation, the capacity of the activated carbon is significantly reduced, requiring frequent replacement of the sorbent media at greatly increased cost and liability of solid waste generation.

Based on personal contact with a manufacturer, sorption processes are well suited for smaller (<400 GT) vessels because they are relatively compact, have relatively low capital cost and cost of operation for treating modest volumes of bilgewater, and require relatively low maintenance other than media replacement (see Attachment B). Replacement is straight forward if the sorbent media is configured as modular cartridges, similar to under-sink water treatment devices.

3.3.2 Biological Treatment

Biological treatment employs microorganisms to convert the substrate (oil and other organic compounds) to carbon dioxide, cell components, and products typical of the usual catabolic pathways. The microorganisms are grown as a film attached to a synthetic support media in a bioreactor (see Attachment A). Oil and related contaminants are degraded in this bio-layer as the bacteria oxidize the hydrocarbons. Aerators, located beneath the media, provide the oxygen required to support bacterial growth and oxidation of the targeted organic contaminants. Nutrient addition and pH adjustment of bilgewater is also usually necessary. Biological treatment of oily bilgewater typically consists of an OWS, the bioreactor, and a final clarifier, which removes microorganisms (biomass).

Biological treatment can degrade organic pollutants (i.e., bilge oil) to low concentrations, even in the presence of detergents and other bilge contaminants. Emulsified oil, which can be difficult to treat by physical/chemical treatment processes, is readily degraded by microorganisms in biological treatment since small oil droplets are processed quickly (Caplan et al. 2000). Furthermore, biological treatment is effective at removing other organic pollutants that may be of concern such as glycols, solvents, jet fuel, surfactants, detergents, nitrogen and phosphates. Biological treatment produces essentially no waste oil, which can be a significant advantage of this technology. Biological treatment is also mechanically simple and functions well under conditions of moderate throughput with controlled loading. Loading spikes can overwhelm and upset biological units, and the microorganisms upon which they rely are

⁹ Activated carbon is a porous material with adsorption of organic molecules occurring within micropores. Oil droplets larger than the micropore diameter (10-1,000 angstroms) may cover the pore, thereby preventing any further adsorption.

sensitive to temperature, pH and nutrient concentrations (Alper, 2003). Capital costs are relatively high, although operating costs are relatively low. The degree of operator skill necessary for the proper function of biological treatment may be higher than that required for other polishing processes.

3.3.3 Coagulation and Flocculation

Coagulation and flocculation are associated processes used to aggregate particles too small for gravitational settling into larger, more readily settleable aggregates. In the case of oil (especially emulsified oil), the separation of the aggregated particles may also be accomplished by flotation. In oily bilgewater treatment, coagulation and flocculation are often referred to as “emulsion breaking”. Following the separation of free oil in an OWS, the remaining emulsified bilgewater is directed to a circulation tank where a flocculent chemical and, in the case of flotation, air are added to the water. Tank mixing is provided by a circulation pump or mechanical stirrers. The aggregation of colloidal particles involves two separate and distinct steps (Weber, 1972): particle transport to effect interparticle contact and particle destabilization to permit attachment when contact occurs. The aggregated flocks that form with the oil are then skimmed off, and the remaining water may undergo through a number of filtering steps. Flocculation can also be used in conjunction with high performance gravity separation devices (generally a centrifuge).

Coagulation and flocculation is effective if properly applied, although it can suffer from several shortcomings (Cheryan and Rajagopalan, 1998). These include:

- High susceptibility to changes in influent quality,
- Optimization aboard each vessel to determine the type and quantity of chemicals required, and
- Skilled operators and careful control (or sophisticated automation) to optimize performance.

Chemical addition is a daily or hourly process and a significant operating cost. Coagulation and flocculation can generate considerable quantities of sludge requiring disposal. According to manufacturers, as much as 5 to 25% of the volume of oily water treated by flocculation chemicals can become residual waste for onshore disposal (Zhu et al., 1997; Attachment B).

3.3.4 Flotation

Air or gas flotation can be used to enhance gravity separation. Flotation uses the differential density between the air or gas bubbles to which the oil droplets and small solid particles become attached and the water to effect separation. Since the agglomerates have a lower density than the medium in which they are immersed, they rise to the surface where they are removed by skimming.

Flotation has been used to treat oil-bearing effluents from a wide variety of sources, including bilge and ballast waste aboard vessels (Bennett and Peters, 1988). There are different types of flotation systems classified based on their method of bubble formation. Dissolved air flotation (DAF), for example, relies upon gas released from a supersaturated solution as a result of pressure reduction. As mentioned above, the flotation step is often augmented by the addition

of flocculating agent and may be followed by additional gravity separation as a safety precaution (Lysyj and Russell, 1979).

3.3.5 Membrane Technologies (Ultrafiltration)

Membrane technologies, in essence molecular sieves, have been used to produce purified water in numerous municipal and industrial applications. Membrane processes have been found to be an effective method for the treatment of oily effluents due to high efficiency in hydrocarbon removal, relatively low energy requirements, no chemical addition and relatively low space requirement (Cheryan and Rajagopalan, 1998). Membrane operations typically fall into three categories: ultrafiltration (UF), nanofiltration (NF) and reverse osmosis (RO) with the following particle size and molecular weight (MW) ranges presented in Table 1.

Table 1: Reverse Osmosis Particle Size and Molecular Weight Ranges

Membrane Technology	Particle Size Cutoff	Molecular Weight (MW) Ranges	Components Retained
Ultrafiltration	0.01 to 0.1 μm	1,000 – 100,000	most organics over 1000 MW
Nanofiltration	0.001 to 0.008 μm (10 to 80 angstroms)	200 – 10,000	95% divalent ions, 40% monovalent ions, organics greater than 150-300 MW
Reverse Osmosis	0.0005 to 0.0015 μm (5 to 15 angstroms)	100 – 300	99% of most ions, most organics over 150 MW

Source: (Cheryan and Rajagopalan, 1998)

Membrane processes have gained wide acceptance because they consistently produce effluents of acceptable discharge quality, and they are perceived to be a simple process from an operational viewpoint (Cheryan and Rajagopalan, 1998). Membranes act as positive barriers to rejected components, so the quality of the treated water tends to be uniform regardless of influent variations. These variations may decrease the permeate flux, but generally do not affect quality of its output.

Ultrafiltration (UF) has been the primary membrane technology used for post OWS bilgewater polishing. UF devices separate high molecular weight constituents and solids from fluids by forcing the fluid through the very small pores of a polymeric or inorganic membrane. UF membranes allow the passage of water, ions, or small molecules, but prohibit the passage of oil and other larger molecules¹⁰. UF operates at relatively low pressure (0.7–7 bar) because the osmotic pressure exerted by the high molecular weight solutes is negligible, and the membranes are designed to separate such solutes (Bodzek and Konieczny, 1992; Karakulski et al., 1995). Membrane systems produce two output streams: the permeate, which is the treated water, and the concentrate, which may contain up to 50% oil. The concentrate is typically recycled back to the bilgewater holding tank. As the oil recovered with the concentrate is usually de-emulsified, it can be readily separated by the OWS upon its subsequent pass through the treatment system. Based

¹⁰ Based on personal communication with Coffin World Water Systems, Oil typically occurs as macromolecules in water, not as discrete molecules (see Attachment B).

on personal communication with a manufacturer, experience has shown that bilge separators incorporating UF generate waste oil at a rate of less than 15% of the treated bilgewater flow rate (see Attachment B).

The treatment of bilgewater by UF has been demonstrated to substantially reduce the content of oil to less than 5 ppm (Gryta et al., 2001). Ceramic module UF systems have been tested and used on U.S. Navy ships for treatment of oily bilgewater with generally good results. The systems are able to reduce oil concentrations from approximately 232 ppm to less than 5 ppm at flows of about 1 m³/hr.

The *Discharge Assessment Report* (DAR) prepared by the U.S. Department of the Navy's Naval Sea Systems Command and the EPA's Office of Water (Navy and EPA, 2003) included technical analyses of surface vessel bilgewater discharges. The DAR concluded that membrane filtration passes as a Marine Pollution Control Device (MPCD) option for treating bilgewater, and that membrane filtration is successfully used onboard Armed Forces surface vessels to treat bilgewater. In the companion *Characterization Analysis Report* (ChAR) (Navy and EPA, 2002), the Navy conducted an evaluation of a membrane filtration system to determine its ability to consistently produce an effluent that would conform to local and worldwide environmental standards regardless of influent concentrations. The test results indicated that membrane filtration is capable of conforming to these standards while operating over a wide range of pH and is resistant to chemical attack. High concentrations of inorganic and organic compounds led to reduced membrane performance; however, most membranes recovered significantly when flushed with water for 15 minutes.

The effectiveness of several bilge separators with UF polishers installed in U.S. Naval vessels was studied in 1999 and 2000 (ERG, 2004). These were real-world tests conducted onboard vessels, with bilge separators treating actual (not synthetic) bilgewater. The oil concentrations in untreated and treated bilgewater were measured using approved analytical methods, and the data were fully quality assured. The UF-polished effluent oil concentrations were almost always less than or equal to the SGT-HEM 5 ppm detection limit. The average OWS/UF effluent oil concentration was 5.5 ppm SGT-HEM¹¹ when the OCM set point was 15 ppm. The OWS/UF systems had a much higher percent removal of oil (80%) than the bilge separators with only gravity OWS (9%).

The inherent tendency of membranes to catch all but the smallest particle sizes renders them susceptible to the accumulation of fouling by organic, inorganic and biological materials on the membrane surface, referred to as membrane fouling. Fouling causes the permeate flux in UF to decrease over time. Because of fouling, UF processes must be stopped regularly for membrane cleaning to restore membrane permeability (Lee et al., 2002). Membrane cleaning, as well as other measures for fouling control, increases cost and complexity of the processes significantly and makes membrane processes less competitive in many application (Lee et al., 2002).

The advantages of treatment using membrane technologies are consistently high efficiency of the separation, a low rate of residual waste oil generation, and reasonably low operating cost (Gryta et al., 2001). Disadvantages of UF include high capital and maintenance costs, if fouling becomes a recurring problem. According to personal communication with a

¹¹Non-detect oil concentrations were set equal to the detection limit for this analysis.

manufacturer and as described in system documentation, membranes must be replaced when fouled, approximately every 3 to 5 years (see Attachments A and B).

3.4 RESIDUAL GENERATION

All bilge separator treatment systems generate oily residuals and sludge. At a minimum, the effective treatment of 1,000 gallons of bilgewater containing 500 ppm of oil will generate 0.5 gallons of oily waste. Actual residual generation varies based on the characteristics of the bilgewater and the specific treatment technologies used in the bilge separator. Residuals generated by treatment technology are summarized in Table 4.

Table 2: Residuals Generated From Treatment Technologies

Treatment Technology	Residual Generated
OWS gravity separator	Oily (free) waste and sludge
Centrifugal separator	Oily (free & emulsified) waste and sludge
Organoclay absorption	Oily solid waste (spent clay)
GAC adsorption	Oily solid waste (spent GAC)
Biological treatment	Sludge and biosolids
Coagulation and flocculation	Oily sludge
Flotation	Oily sludge
Ultrafiltration	Oily (free & emulsified) waste

3.5 OIL CONTENT MONITOR

All vessels over 400 GT are required to have an oil content monitor (OCM), including a bilge alarm, integrated into the piping system to detect whether the treated bilgewater that is being discharged from the bilge separator meets the discharge requirements. Standards for type approval of OCMs are defined under 46 CFR 162.050 and MARPOL 73/78 Annex I (see Section 2). When the oil content in the effluent is detected to exceed these limits, an alarm and discharge stopping device (typically a valve that diverts the noncompliant effluent back to the bilge separator to be reprocessed) is activated. Given that the OCM plays a primary role in the operation of the bilge separator treatment system, and is usually the only means of preventing the discharge of oil from vessels in the case of failure of the bilge separator, the accuracy and reliability of the OCM is an important consideration in the overall evaluation of the effectiveness of bilge separators.

The mixture of fluids accumulating in a vessel bilge can be difficult to monitor, even with the best OCM equipment (EPA, 2008). OCMs measure the oil content in the effluent by increasing the turbidity of a sample using ultrasonic emulsification. The turbidity increase of the sample is proportional to the oil concentration, which is electronically converted to ppm. However, bilge contaminants other than oil that contribute turbidity (e.g., suspended solids, soot) can interfere with these measurements. Unfortunately, this means that most OCMs are unable to differentiate between oil and other bilgewater contaminants. Automated measurement of oil concentrations as low as 5-15 ppm is difficult due to the variation of oil constituents, other contaminants and emulsifying detergents (EPA, 2008).

OCMs require continuous maintenance and cleaning to avoid malfunctions and erroneous readings due to interferences with the turbidity they monitor. For example, personal communication with a manufacturer indicated that more than half of the OCM readings above 5 ppm aboard one Great Lakes shipping company's vessels were suspected to be erroneous (see Attachment B). This is problematic because (1) it causes the bilge separators to recirculate instead of discharging clean effluent and (2) these readings are recorded and saved for 18 months for regulatory review. The accuracy of the OCMs this company uses aboard their vessels is reportedly ± 5 ppm, hence the OCM readings in this concentration range are questionable.

ERG (2004) assessed available data published by the U.S. Navy to determine whether bilge separators with OCMs set at 15 ppm actually achieve effluent oil concentrations below 15 ppm SGT-HEM. ERG analyzed 125 OCM readings and the corresponding actual effluent oil concentrations and found no correlation (coefficient of determination, $r^2=0.0012$) between them. In other words, the OCM readings bore no relationship to the SGT-HEM concentrations they were supposed to monitor. A more detailed evaluation of shipboard sampling of bilgewater on seven Navy vessels during eight sampling episodes (i.e., one vessel was sampled twice) was also presented. In several cases on one Navy vessel, the OCM reading following the OWS was zero while the SGT-HEM effluent concentration was in the 15 to 50 ppm range. At least two of the Navy vessels that were sampled possibly discharged bilgewater overboard that had SGT-HEM concentrations greater than 15 ppm, due to inaccuracy in the OCM readings. Inaccurate and unreliable OCMs make it more likely that oil will be inadvertently discharged overboard.

Some newer OCMs overcome these problems by using UV fluorescence technology to detect oil molecules in bilgewater. Oil is comprised of fluorescent compounds, each having a unique wavelength "signature". Using fluorescence, these compounds can be detected as an actual concentration of oil in water, with detection limits down to the parts per billion level. Fluorescence OCMs are resistant to interferences by turbidity or particles/sediments in the bilge, which affects turbidity-based OCMs (particles such as silt, algae, iron oxide do not fluoresce at oil's wavelength, they do not interfere with the measurement of oil concentration) (see Attachment A). Several fluorescence OCMs have been IMO MEPC 107(49) certified and type-approved by the U.S. Coast Guard for use as a 15 ppm bilge monitor/bilge alarm. However, personal communication with a manufacturer indicates that such OCMs are as much as 10 times more expensive than the OCMs commonly installed aboard vessels (see Attachment B).

3.6 SPACE REQUIREMENTS

The space required for bilge separator treatment systems is another concern for vessel operators because mechanical space aboard ship (existing or new vessels) is at a premium. EPA calculated the "footprint" required for a variety of bilge separator treatment systems, based upon the dimensions provided by manufacturers for skid-mounted systems sized for a 1 m³/hr capacity. The results, compared in the bar graph below, show that bilge separator treatment systems of this capacity have footprints ranging from 0.6 to 3.4 m², a range of a factor of six. The largest bilge separators are the bioreactor-based system, a centrifuge system, one of the flotation/coagulation & flocculation-based systems, and one of the UF-based systems. Interestingly, the two OWS/UF systems have quite different footprints, 0.86 and 2.42 m². The smallest bilge separators are both OWS-adsorber treatment systems; these systems are only slightly larger than the older generation of single-stage gravity OWS (indicated in the figure below as OWS*) that do not meet the MARPOL 15 ppm oil discharge standard. Most vendors

address the issue of retrofitting bilge separators into existing confined spaces by reconfiguring their systems as separate components, as opposed treatment systems mounted on a single skid.

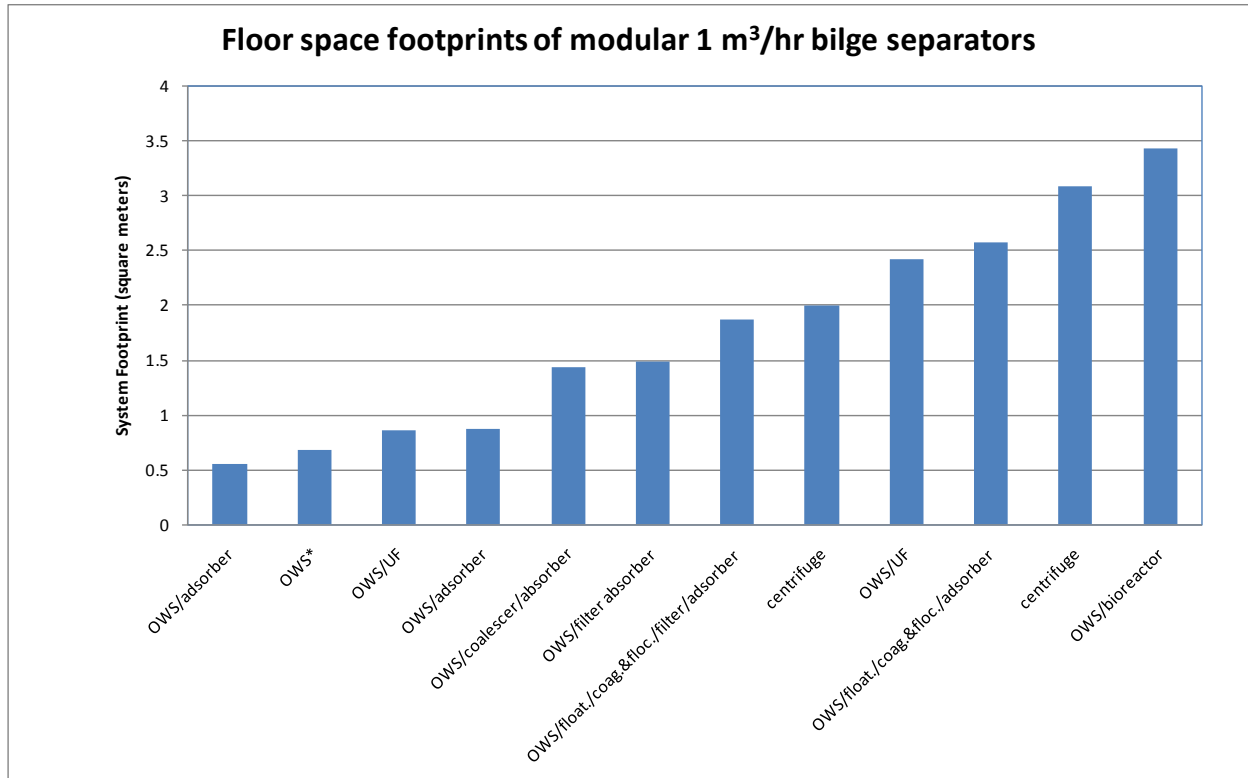

Figure 1: Footprint Required for Various Bilge Separator Treatment Systems

SECTION 4

EFFECTIVENESS OF BILGE SEPARATOR TREATMENT TECHNOLOGIES

EPA evaluated the effectiveness of bilge separators based on their ability to achieve low effluent oil concentrations. Ideally, this evaluation would be based on the analysis of oil concentrations in samples of effluent collected from bilge separators treating actual bilgewater onboard operating vessels. However, very few representative data of this sort are available. Instead, the effectiveness of bilge separators is usually demonstrated by the results of certification tests, conducted by an independent laboratory, of effluent oil concentrations achieved by bilge separators treating synthetic oily bilgewater. For a number of reasons (discussed below) these tests may not accurately represent the actual effectiveness of bilge separators in the real world. However, the certification test data demonstrate that different bilge separators can achieve less than 15 ppm effluent oil concentrations under controlled conditions.

Paradoxically, there is also considerable anecdotal evidence that some bilge separators have difficulty meeting the 15 ppm MARPOL discharge standard onboard vessels. For example, the Association Francaise des Capitaines de Navires (AFCAN, 2006) reported that bilge separators brought into service in 2005 had “difficulties” treating bilgewater to reduce hydrocarbon contents below 200 ppm. Presumably, these bilge separators were type-certified to meet the current MARPOL regulations. Other problems with the performance of bilge separators aboard ships have been reported by marine engineers (MarineTalk discussion forum, accessed July 20, 2010). Further evidence is provided by the ongoing prosecution in the U.S. of vessel masters and chief engineers for violating the APPS by using “magic pipes” (i.e., circumventing the required pollution prevention equipment and discharging oil sludge and oil contaminated waste directly overboard, generally due to failure of the bilge separator). However, some of the problems reported with the performance of bilge separators may reflect experience with older (pre MARPOL 73/78) treatment systems, which were often single-stage OWS.

Vendors of bilge separators often promote their own treatment systems as superior to other systems, for a variety of reasons (e.g., performance, reliability and cost). Such opinions may reflect marketing or actual experience, but are rarely confirmed by independent, verifiable data. Thus, it is difficult to use such anecdotal information objectively regarding the pros and cons of different bilge separator treatment systems. Given that a number of different bilge separator treatment systems have been demonstrated to perform effectively via certification, it is reasonable to conclude that no one system is necessarily “best”. Rather, multiple bilge separator treatment systems appear capable of meeting the 15 ppm standard and possibly the 5 ppm standards for effluent oil concentrations.

Although EPA does not endorse specific bilge separators, system information and performance data gathered for thirteen bilge separators are summarized below. These bilge separators are not necessarily representative of all of the systems on the market because: (1) it is a small sample size and (2) some of the vendors that responded declined to provide effectiveness and/or cost data. Although not necessarily representative, this summary illustrates that bilge separator treatment systems using different treatment technologies and combinations of unit operations can achieve and exceed compliance with existing U.S. Coast Guard certification standards, and some may have the potential to meet 5 ppm limits.

4.1 BILGE SEPARATOR TREATMENT SYSTEM A

This bilge separator treatment system consists of an OWS, followed by a strainer/prefilter, followed by a PS-infused spun polypropylene filter absorber. According to the vendor, the polymer attracts and bonds hydrophobic and oleophilic compounds, including oil. The vendor, which holds a patent for the absorbent polymer, also markets the filter as a polisher for other OWS systems. Based on technical product sheets, the filters can be regenerated and the recovered oil can be rendered water-free using centrifugation. Alternatively, the spent filters can be used for fuel or stored for later disposal (see Attachment A).

The vendor provided their Lloyd's Register Certificate for testing of their 1.0 m³/hr and 2.5 m³/hr bilge treatment systems. For tests using MEPC 107(49) test fluid "C" emulsion, influent oil concentrations of 50,000, 100,000 and 150,000 ppm hydrocarbon index were reduced to effluent concentrations of 0.14 to 0.48 ppm. The average effluent concentration from seven tests was 0.26 ppm.

4.2 BILGE SEPARATOR TREATMENT SYSTEM B

This bilge separator treatment system consists of an OWS, followed by a biological reactor containing support media, followed by a clarifier/monitoring chamber. The biological reactor is started up by filling with water and inoculating with hydrocarbon-degrading microorganisms. According to the vendor, refined oils and other petroleum products found in bilgewater may contain thousands of different hydrocarbons. To biodegrade these compounds, microorganisms use numerous different enzymes to biochemically catalyze many reactions (e.g., oxidation, reduction, hydroxylation, ring cleavage). A "starter" bacterial culture in the form of a dry powder is provided by the manufacturer for this initial inoculation (Penny and Suominen-Yeh, 2006).

Penny and Suominen-Yeh (2006) presented data (Table 2) on the performance of this bilge separator treatment system onboard three commercial vessels (an ore carrying freighter, a ferry and a passenger/ferry) over a two year period. Note that effluent oil concentrations tabulated below were measured using the OCM, as opposed to laboratory analytical data of known quality.

Table 3: Performance of Bilge Separator Treatment System on Three Commercial Vessels

Vessel	Design Flow Rate (m ³ /hr)	Average Treatment Flow Rate (m ³ /hr)	Average Effluent Oil Concentration (OCM ppm)	Range of Effluent Oil Concentration (OCM ppm)	Number of Samples
Freighter	0.5	0.3	5.2	<1 - 14	31
Ferry	0.2	0.07	6.0	<1 - 14	58
Passenger/ferry	0.3	0.1	7.6	<1 - 20	31

Source: (Penny and Suominen-Yeh, 2006)

Daily maintenance items for this biomechanical bilge separator treatment system include nutrient addition and maintaining the pH level within the required range. Weekly and bi-weekly maintenance includes nutrient analysis and removal of accumulated biomass and other settled solids. This treatment system does not require filters, sorbent media or similar disposable materials to remove oil from the liquid phase.

The vendor provided their summation certificate for testing of their 0.45 m³/hr, 0.68 m³/hr and 0.86 m³/hr bilge treatment systems. For tests using MEPC 107(49) test fluid “C” emulsion, influent oil concentrations of 6% (60,000 ppm) hydrocarbon oil index were reduced to effluent concentrations of 1.3 to 1.8 ppm. The average effluent concentration from three tests was 1.6 ppm.

4.3 BILGE SEPARATOR TREATMENT SYSTEM C

This bilge separator treatment system consists of DAF/oil skimming, followed by coagulation and flocculation, DAF/sludge skimming and activated carbon adsorption. This treatment system is being used aboard roll-on/roll-off (RoRo) and roll-on/roll-off passenger (RoPax) ferries. The vendor provided their U.S. Coast Guard certificate of approval for testing of their 0.55 m³/hr and 2.0 m³/hr bilge treatment systems by SGS Institut Fresenius GmbH of Taunstein, Germany. For tests using MEPC 107(49) test fluid “C” emulsion, influent oil concentrations of 5.8-5.9% (58,000-59,000 ppm) hydrocarbon oil index were reduced to effluent concentrations of less than 1 ppm.

The vendor of this system also provided third party data for oil and hydrocarbon index concentrations from samples of bilgewater effluent following system start up and after 2 years of operation aboard vessels. In both cases, the effluent oil concentrations were below detection (detection limits of 1.0 and 0.1 ppm). This bilge separator treatment system also has a 5 ppm Type Approval Certificate from the French Bureau Veritas International Register.

4.4 BILGE SEPARATOR TREATMENT SYSTEM D

This bilge separator treatment system consists of an OWS, followed by 100- μ m prefilter and polishing by UF. Ghidossi et al. (2009) present data on the performance of this bilge separator treatment system during 6 month trials aboard two >20,000 GT ferries operating in the Mediterranean. The system consisted of two 7 m² 300-kDa¹² ceramic membranes treating 1 m³/hr, considered an average bilgewater flow rate for such vessels. The UF system was operated at a volumetric concentration factor (VCF=feed Q/concentrate Q) of three. Membrane permeability after regeneration every two days did not vary. The influent hydrocarbon (HC) concentration of approximately 500 ppm was reduced to 100-200 ppm by the OWS. UF permeate HC concentrations were less than 1 ppm. Tests performed using UF without OWS pretreatment demonstrated that the strong reduction of HC content by the OWS was necessary for effective treatment of oily bilgewater by this system. An episode of treating wastewater contaminated by chimney soot also demonstrated the importance of effective pretreatment for UF; the soot permanently blocked the membrane pores, requiring the replacement of the UF membranes.

The vendor provided their U.S. Coast Guard certificate of approval for testing of their 0.55 m³/hr and 2.0 m³/hr bilge treatment systems by Tei Testing Services. For tests using MEPC 107(49) test fluid “C” emulsion, influent oil concentrations of 6% (60,000 ppm) hydrocarbon oil index were reduced to effluent concentrations of 1.5 to 2.5 ppm. The average effluent concentration from six tests was 1.75 ppm.

¹² Nominal molecular weight cutoff of approximately 300,000.

4.5 BILGE SEPARATOR TREATMENT SYSTEM E

This bilge separator treatment system consists of a strainer and preheater, followed by a high-speed centrifugal separator. To ensure a 5 ppm effluent oil concentration, the system includes an organoclay absorber is added as a final polishing step. Since the oil content in the effluent the centrifugal separator is less than 15 ppm, the corresponding oil loading to the absorber is low, requiring only annual replacement of the organoclay. According to the manufacturer, the largest market for the centrifugal separators is large oil tankers. Centrifuges treating bilgewater are used aboard large cruise ships.

The vendor provided their U.S. Coast Guard certificate of approval for testing of an older 2 m³/hr centrifuge-based bilge separator treatment system. The tested system did not include an organoclay polisher. For tests using MEPC 107(49) test fluid “C” emulsion, influent oil concentrations of 6 and 6.1% (60,000-61,000 ppm) hydrocarbon oil index were reduced to effluent concentrations of 8.4 to 11.0 ppm. The average effluent concentration from three tests, conducted without the organoclay polisher, was 9.5 ppm. Testing of this system with the polisher produced effluent oil concentrations in compliance with DNV Clean Design Rules 5 ppm effluent limit. Seaway Marine Transport, a Canadian shipper operating 24 freighters on the Great Lakes, has installed centrifuge-based bilge separators on their vessels. Based on personal communication with a manufacturer (see Attachment B), the centrifuge-based separators routinely produce 0-2 ppm effluent oil concentrations without tertiary (organoclay filter) polishing.

4.6 BILGE SEPARATOR TREATMENT SYSTEM F

This bilge separator treatment system consists of a hydrophobic high viscosity removal system (a low turbulence OWS), an oleophilic filter that also coalesces emulsified oil, and an adsorber using an advanced granular media (AGM). According to the manufacturer’s representative, the AGM is an organoclay material (see Attachment B).

Maintenance of this system consists of periodic replacement of the oleophilic filter and AGM. The second stage coalescer element is not degraded by oils but acts as a particle filter and must be replaced when it becomes plugged by solids or sludge. The third stage adsorber holds 100 kg of AGM. The rate at which these consumables must be replaced depends on both the quantity (flow rate) and the quality (in terms of oil and suspended solids loading) of the bilgewater being treated.

The vendor provided their U.S. Coast Guard certificate of approval for testing of their 1.0 m³/hr bilge treatment system by Institute Fresenius of Taunusstein, Germany. For tests using MEPC 107(49) test fluid “C” emulsion, influent oil concentrations of 6% (60,000 ppm) hydrocarbon oil index were reduced to effluent concentrations below the 1 ppm detection limit. The average effluent concentration from three tests was <1 ppm.

4.7 BILGE SEPARATOR TREATMENT SYSTEM G

This bilge separator treatment system consists of a “descaler” hydrocyclone OWS, a reactor combining coagulation, flocculation and flotation, an Aqualite (volcanic rock) granular media filter, and activated carbon polishing as a final stage. The second stage reactor, which is responsible for separating emulsified oil (i.e., emulsion breaking), is optimized for minimal

residual sludge generation, and automated to reduce the time required for operation and maintenance (O&M). According to the manufacturer, steam regeneration is used to extend the life of the Aqualite and activated carbon media, allowing for annual replacement (see Attachment B).

The vendor's U.S. representative provided their U.S. Coast Guard Certificate of Approval for testing of their 1 and 4 m³/hr bilge treatment systems by Institut Fresenius AG of Taunusstein, Germany. For tests using MEPC 107(49) test fluid "C" emulsion, influent oil concentrations of 8% (80,000 ppm) hydrocarbon oil index were reduced to effluent concentrations below the 1 ppm detection limit.

The manufacturer also provided performance data for this bilge separator treatment system onboard a car ferry over a one year period. This system treated an average daily bilgewater flow of 5.3 m³/day, achieving monthly average effluent oil concentrations of 0.7 to 2.2 ppm. These concentrations were measured using the OCM, as opposed to laboratory analytical data of known quality.

4.8 BILGE SEPARATOR TREATMENT SYSTEM H

This bilge treatment system uses a modular design consisting of a feed pump, automatic filter, preheater, self-discharging separator, oil monitor and control panel.

Type-approval testing using MEPC 107(49) test fluid "C" emulsion with an influent oil content of 6% (60,000 ppm) yielded effluent oil content concentrations ranging between 6 and 10 ppm for the 1.5 to 3 m³/hr treatment units. Type-approval testing of the treatment systems as large as 7 m³/hr yielded a consistent 5 ppm effluent oil concentration when MEPC 107(49) test fluid "C" emulsion was used.

4.9 BILGE SEPARATOR TREATMENT SYSTEM I

EPA was unable to identify the treatment technologies that comprise this system. The vendor provided their Lloyd's Register Certificate for testing of their 4.0 m³/hr bilge treatment system. For tests using MEPC 107(49) test fluid "A" having oil concentrations as high as 250,000 ppm, the system yielded effluent oil concentrations ranging from less than 0.1 ppm to 0.26 ppm measured by the hydrocarbon oil index method. For tests using MEPC 107(49) test fluid "C" with an influent oil concentration of 60,000 ppm, the bilge treatment system produced an effluent having oil concentrations ranging from 0.1 ppm to 0.42 ppm measured by the hydrocarbon oil index method.

4.10 BILGE SEPARATOR TREATMENT SYSTEM J

EPA was unable to identify the treatment technologies that comprise this system. The vendor provided their Lloyd's Register Certificate for testing of their 6.0 m³/hr bilge treatment system. For tests using MEPC 107(49) test fluid "A" having oil concentrations as high as 250,000 ppm, the system yielded effluent oil concentrations ranging from less than 0.1 ppm to 1.14 ppm measured by the hydrocarbon oil index method. For tests using MEPC 107(49) test fluid "C" with an influent oil concentration of 60,000 ppm, the bilge treatment system was able to produce an effluent having oil concentrations ranging from 3.4 ppm to 4.7 ppm measured by the hydrocarbon oil index method.

4.11 BILGE SEPARATOR TREATMENT SYSTEM K

This bilgewater treatment system consists of an oil filter. The vendor provided their SEE-Berufsgenossenschaft Certificate of Type Approval, issued in Hamburg, Germany, for testing of their 1.0 m³/hr bilge treatment system. For tests using MEPC 107(49) test fluid “A” having oil concentrations as high as 250,000 ppm, the system yielded effluent oil concentrations of 0.1 ppm or less measured by the hydrocarbon oil index method. For tests using MEPC 107(49) test fluid “C” with an influent oil concentration of 60,000 ppm, the bilge treatment system was able to produce an effluent having oil concentrations consistently less than 0.1 ppm measured by the hydrocarbon oil index method.

4.12 BILGE SEPARATOR TREATMENT SYSTEM L

This bilgewater treatment system consists of an oil absorption filter. The vendor provided their Lloyd’s Register Certificate for testing of their 2.5 m³/hr bilge treatment system. According to the Certificate of Type Approval, the system is designed to produce an effluent of 5 ppm of oil or less when the influent oil concentration is less than 100 ppm.

For testing using MEPC 107(49) test fluid “A” having an oil content ranging between 0.47 ppm and 127 ppm, the system yielded effluent oil concentrations ranging from 0.51 to 1.52 ppm. For tests using MEPC 107(49) test fluid “C” with an influent oil content ranging between 0.08 ppm and 210 ppm, the bilge treatment system was able to produce an effluent having an oil content ranging from 0.72 ppm to 1.6 ppm.

4.13 BILGE SEPARATOR TREATMENT SYSTEM M

EPA was unable to identify the treatment technologies that comprise this system. The vendor provided their Lloyd’s Register Certificate for testing of their 4 m³/hr bilge treatment system. For testing using MEPC 107(49) test fluid “A” having an oil content as high as 250,000 ppm, the system yielded effluent oil concentrations ranging from less than 0.1 to 0.38 ppm measured using the hydrocarbon oil index method. For tests using MEPC 107(49) test fluid “C” with an influent oil concentration of 60,000 ppm, the bilge treatment system was able to produce an effluent having an oil content ranging from 0.4 ppm to 1.1 ppm measured using the hydrocarbon oil index method.

4.14 SUMMARY OF BILGE SEPARATOR EFFECTIVENESS

Table 3 summarizes effluent oil concentrations measured for these bilge separator treatment systems. (The complete set of vendor submitted performance data can be found in Attachment C.) The data presented focus primarily on type certification data for bilgewater treatment systems that were tested using MEPC 107(49) test fluid “C” since this fluid is likely the most challenging for the treatment unit and is most similar to actual oily bilgewater. For example, test fluid “C” is an oil/water emulsion that contains both marine residual fuel oil and marine distillate fuel oil, a surfactant (e.g., soaps) and iron oxide (corroded metal and suspended solids). The emulsion is created by circulating this mixture through a centrifugal pump for more than one hour. Eleven of the thirteen systems profiled above achieved average effluent hydrocarbon index concentrations below 5 ppm when treating MEPC 107(49) test fluid C emulsion during certification tests. One of the systems that did not achieve 5ppm lacked the polishing step during testing which is currently available from its vendor. Of the three systems

that had monitoring data from vessels in service, two achieved comparable effectiveness. The one system produced somewhat higher effluent concentrations (5.2-7.6 ppm) aboard vessels in service was OCM data of unknown quality. Although the data from vessels in service is very limited, it suggests that certification tests conducted with the MEPC 107(49) test fluid C emulsion may be representative of real world performance, at least for these treatment systems. As previously noted, this summary illustrates that bilge separator treatment systems, using different treatment technologies and combinations of unit operations, can achieve and exceed compliance the current 15 ppm U.S. Coast Guard certification standard.

Table 4: Effluent Oil Concentrations for Bilge Treatment Systems

Bilge Separator Treatment System	Effluent oil concentration (ppm) from MEPC 107(49) testing using fluid C emulsion	Effluent oil & hydrocarbon index (ppm) from vessels in service	Effluent oil concentration (OCM ppm) from vessels in service
System A (OWS/PS absorber)	0.26 (0.14-0.48)		
System B (OWS/Biological Reactor/Clarifier)	1.6 (1.3-1.8)		5.2 (<1-14) 6.0 (<1-14) 7.6 (<1-20)
System C (DAF/coag.-floc./DAF skimming/GAC)	<1	< DL (1.0 and 0.1)	
System D (OWS/prefilter/UF)	1.75 (1.5-2.5)	<1	
System E (Strainer/preheat/centrifuge)	9.5 (8.4-11.0) ^a		
System F (OWS/filter coalesce/AGM adsorber)	<1		
System G (Descaler OWS/ coagulation- flocculation- flotation/granular media filter/ GAC)	<1		0.7 – 2.2 (monthly average values)
System H (Filter/preheat/OWS)	6.7 (5–10)		
System I (unknown)	0.22 (0.1-0.42)		
System J (unknown)	4.1 (3.4–4.7)		
System K (Oil absorption filter)	<0.1		
System L (Oil absorption filter)	1.7 (0.72–2.7)		
System M (unknown)	0.8 (0.4–1.1)		

^aData were provided from U.S. Coast Guard certificate of approval for testing of an older version of the centrifuge-based bilge separator. This system did not include an organoclay polisher.

Bilge separator manufacturers and vendors, as well as major shipping companies, indicate that there is a difference between bilge separator treatment systems that meet a 5 ppm oil standard versus those that meet a 15 ppm oil standard, the former requiring greater effort. Based on personal communication with the manufacturer, their experience is that meeting 5 ppm oil standards for bilgewater discharge is possible, although it requires a serious commitment to acquiring and maintaining effective bilge separators and OCMs, along with following guidance

such as the IMO/MEPC's *Integrated Bilgewater Treatment System* (IBTS) practices (IMO/MEPC, 2008; Attachment B).

4.15 LIMITATIONS OF CERTIFICATION TEST DATA

The MEPC 107(49) certification tests, although an improvement over earlier tests, have also been criticized as insufficient to replicate actual conditions onboard vessels. Several treatment system vendors indicated the certification tests are too limited to measure the true effectiveness of bilge separator treatment systems under real-world conditions aboard vessels (TANKEROperator, 2009). There are three primary criticisms:

- **The duration of the tests is too short.** During testing the bilge separator treat each of three test fluids for only 2.5 hours. These tests can be passed using simple filters that, in actual service, would be incapable of maintaining performance over longer time periods.
- **The tests are conducted on stationary treatment systems.** The pitching and rolling motion aboard vessels would reduce the effectiveness of any gravity-based separation method.
- **The rate and composition of the test fluids are constant throughout the tests.** These test condition are unrealistic because bilgewater characteristics vary. Some treatment technologies are better than others in handling oil “shocks” or other variations in bilgewater conditions.

These critics contend that the shortcomings of the MEPC 107(49) certification tests lead to the approval of many bilge separator treatment systems that cannot effectively treat bilgewater aboard vessels. These criticisms are echoed by comments from marine engineers (MarineTalk discussion forum, accessed July 20, 2010).

SECTION 5 REFERENCES

- AFCAN. 2006. Oily waste management onboard of vessels; September 2006 update. Association Francaise des Capitaines de Navires. Accessed September 10, 2010. (http://www.afcan.org/dossiers_techniques/gestion_dech_huileux2_gb.html).
- Alper, H. 2003. Regulatory and technical developments in the treatment of oily bilgewater. Presented at the International Conference on Marine Engineering Systems (ICMES). Finland, May 2003.
- Alper, H. 2001. New Technologies for Controlling Oily Bilgewater Discharges. Presented at the Marine Environmental Engineers Technology Symposium (MEETS), May 2001.
- Alther, G.R. 1995. Organically modified clay removes oil from water. *Waste Management*, Vol. 15, Issue 8, 1995, p. 623-628.
- Bennett, G., and R. Peters. 1988. The removal of oil from wastewater by air flotation: A review. *Critical Reviews in Environmental Science and Technology*, Vol. 18, Issue 3 1988, p. 189-253.
- Caplan, J., Newton, C. and D. Kelemen. 2000. Technical report: Novel oil/water separator for treatment of oily bilgewater. *Marine technology and SNAME news*, 2000, Vol. 37, No2, p. 111-115.
- Bodzek, M. and K. Konieczny. 1992. The use of ultrafiltration membranes made of various polymers in the treatment of oil emulsion wastewaters. *Waste Management*. 12, 75.
- Cheryan, M., and N. Rajagopalan. 1998. Membrane processing of oily streams. *Wastewater treatment and waste reduction. J. Membr. Sci.*, 151, (1998), p. 13.
- DNV. 2005. Guidance for the Environmental Classifications CLEAN and CLEAN DESIGN. Classification Notes No. 62.1. Det Norske Veritas, Norway (<http://exchange.dnv.com/Publishing/CN/CN62-1.pdf>).
- EPA. 2010. Study of Discharges Incidental to Normal Operation of Commercial Fishing Vessels and Other Non Recreational Vessels less than 79 feet. Report to Congress. U.S. Environmental Protection Agency. Washington, D.C. (<http://cfpub.epa.gov/npdes/vessels/reportcongress.cfm>).
- EPA, 2008. Cruise Ship Discharge Assessment Report. Oceans and Coastal Protection Division, Office of Wetlands, Oceans, and Watersheds and Office of Water. U.S. Environmental Protection Agency. EPA 842-R-07-005.
- EPA. 1999. Appendix A; Includes the Surface Vessel Bilgewater/Oil Water Separator: Nature of Discharge for the "Phase I Final Rule and Technical Development Document of Uniform National Discharge Standards (UNDS)," U.S. Environmental Protection Agency. EPA-842-R-99-001. April 1999.

- ERG. 2004. Analysis of UNDS Bilgewater Data. Memo from Joy Abel, Eastern Research Group, to Ron Jordan, EPA. September 10, 2004.
- Ghidossi, R., Veyret, D., Scotto, J.L., Jalabert, T. and P. Moulin. 2009. Ferry oily wastewater treatment. *Separation and Purification Technology*, Vol. 64, Issue 3, 12 January 2009, p. 296-303.
- Gryta, M., Karakulski, K. and A. W. Morawski. 2001. Purification of oily wastewater by hybrid UF/MD. *Water Research*, Vol. 35, Issue 15, October 2001, p. 3665-3669.
- IMO. 2006. Pollution prevention equipment under MARPOL. IMO Publishing, 2006.
- IMO/MEPC. 2008. Revised guidelines for systems for handling oily wastes in machinery spaces of ships incorporating guidance notes for an integrated bilgewater treatment system (IBTS). International Maritime Organization/Marine Environment Protection Committee. November 2008. (<http://www.mardep.gov.hk/en/msnote/pdf/msin0833anx.pdf>).
- Karakulski, K., Kozlowski, A. and A. W. Morawski. 1995. Purification of oily wastewater by ultrafiltration. *Sep. Technol.*, 5, (1995), p. 197.
- Koss, L. 1996. Technology development for environmentally sound ships of the 21st century: an international perspective. *Journal of Marine Science and Technology*, Vol. 1, No. 3, June 1996.
- Lee, S.H., Chung, K.C., Shin, M.C., Dong, J.I., Lee, H.S. and K.H. Auh. 2002. Preparation of ceramic membrane and application to the crossflow microfiltration of soluble waste oil. *Mater. Lett.* 52 (2002), p. 266.
- Lysyj, I. and E.C. Russell. 1979. Effectiveness of Centralized Bilgewater Treatment- A Field Study. *Environment International*. 2;177-182.
- MarineTalk discussion forum. Accessed July 20, 2010. (www.marinetalk.com/forum-post.asp?thread_id=T95040).
- MyCelx. 2009. MyCelx Filters Chosen for NOAA's Fisheries Fleet. Accessed July 20, 2010 (<http://newsguide.us/index.php?path=/technology/industrial/MyCelx-Filters-Chosen-For-NOAA-s-Fisheries-Fleet-Bilge-Water-Filters-Improve-Environmental-Impact-Prevent-Pollution/>)
- Noyes, R. 1993. Pollution prevention technology handbook. Noyes Publications, Park Ridge, N.J.
- Penny, R., and M. Suominen-Yeh. 2006. Biological Bilgewater Treatment System. *Naval Engineers Journal*, Vol. 118, Issue 3, p. 45-50.
- Sun, C., Leiknes, T., Weitzenböck, J. and B. Thorstensen. 2009. The effect of bilgewater on a Biofilm-MBR process in an integrated shipboard wastewater treatment system. *Desalination*, Vol. 236, Issues 1-3, 31 January 2009, p. 56-64.

- Navy and EPA. 2003. Discharge Assessment Report. Surface Vessel Bilgewater. U.S. Environmental Protection Agency, Office of Water, Washington, D.C., and U.S. Navy, Naval Sea Systems Command, Washington, D.C., July 2003.
- Navy and EPA. 2002. Characterization Assessment Report. Surface Bilgewater/ Oil Water Separator (OWS). U.S. Environmental Protection Agency, Office of Water, Washington, D.C., and U.S. Navy, Naval Sea Systems Command, Washington, D.C., December 2002.
- TANKER Operator. 2009. Bilgewater treatment – centrifugal or gravity separation? May 2009. (<http://www.tankeroperator.com>).
- Tomaszewska, M., Orecki, A. and K. Karakulski. 2005. Treatment of bilgewater using a combination of ultrafiltration and reverse osmosis. *Desalinization*. 185: 203-212.
- Weber, W. J., Jr. 1972. *Physicochemical Processes for Water Quality Control*. Wiley-Interscience. New York.
- Zhu, X., Reed, B.E., Lin, W., Carriere, P.E. and G. Roark. 1997. Investigation of Emulsified Oil Wastewater Treatment with Polymers. *Separation Science and Technology*, Vol. 32, Issue 13, August 1997, p. 2173-2187.

ATTACHMENT A:
PUBLISHED LITERATURE FROM VENDOR WEBSITES



Products

PureBilge

[How it works](#)[Documentation](#)[Contact](#)

PureBilge oily water treatment system

PureBilge is a fully automated centrifugal bilge water treatment system that cleans oily wastewater onboard vessels at sea. By effectively removing marine oil pollution, it makes bilge water safe for discharge overboard.



This reliable single-stage high-speed centrifugal separation system effectively cleans large bilge water volumes at sea as well as ashore without the use of chemicals, adsorption filter or membranes.

Cleaning efficiency

PureBilge generally achieves an oil-in-water content of less than 5 ppm. Performance has been proven under real-life operating conditions and is unaffected by sea heave, oil shocks or high solids loading.

Superior separation performance

PureBilge features a patented XLrator disc inlet, which gently accelerates the bilge water as it enters the separator bowl. This prevents the splitting of oil droplets and the formation of additional emulsions, which gives PureBilge a substantial edge over other centrifugal separation systems.

Certified and cost-effective

Certified according to IMO resolutions, MEPC.107 (49) and US Coast Guard document 46 CFR 106.50, PureBilge is designed for unmanned 24/7 operation.

No man-hours are required for operation or supervision. There's also no need to pump ashore and no need to transport land wastes such as filter elements, coalescence elements, active carbon, or flocculation deposits. This contributes to reduced operating costs.

Easy to install in any engine room

Designed for plug-and-play installation, PureBilge is a compact and factory-tested separator module that is easy to install in any engine room. Continuous operation means that there is no need for large bilge water holding tanks, which frees up space and increases payload capacity.

Fully automated monitoring and control

The new EPC 60 Bilge process controller is an easy-to operate, computer-based Alfa Laval process controller. It facilitates advanced fully automated monitoring and control of PureBilge functions by displaying in clear text process parameters, alarms and other data.

PureBilge separation capacities

PureBilge is available in two standard versions:

- PureBilge 2515: 2 500 l/h, 15 ppm
- PureBilge 5015: 5 000 l/h, 15 ppm

PureBilge options

PureBilge includes a broad range of options that further simplify installation and maintenance. Choose the optional equipment that suits your requirements and the existing conditions on board:

- 5 ppm certificate
- Heat recovery
- Safety box
- Flow meter
- Sludge removal kit
- CIP unit
- Chemical dosing unit
- Automatic self-cleaning filter
- Remote control

[Career](#) [Feedback](#) [Legal terms and conditions](#)

About EnSolve Biosystems

Founded in 1995, EnSolve's mission is to provide biotreatment products for maritime customers that yield both economic and environmental benefits. EnSolve's team of professionals includes engineers, microbiologists and service technicians with over 50 years of combined experience in wastewater treatment. EnSolve's award winning PetroLimiterator technology has been employed on ships around the world since 2000 including ferries, oil tankers, ore carriers, oil exploration vessels, cruise ships, off-shore drill rigs, Ro-Ro's, and military ships.



EnSolve
Biosystems, Inc.

EnSolve Biosystems, Inc.
5805 Departure Dr, Suite B
Raleigh, NC 27616
(919) 954-6196 Fax (919) 954-6197
www.ensolve.com



Clean Seas Ahead!

FREQUENTLY ASKED QUESTIONS

What cost savings can I realize with your product?
This varies from ship to ship, but typically operational savings range from 2 to 4 times per year compared with physical/chemical OWS systems

Are any of the microbes, chemicals, nutrients, or byproducts of the process harmful or considered hazardous material?
NO. The microbes, chemicals, and nutrients provided are safe products to handle and use. The by-products of the system are negligible amounts of carbon dioxide (CO₂) and water.

How much labor time does the system take to operate?
The system typically takes less than 15 minutes per day to operate. The PetroLimiterator does not generate large amounts of sludge and can be operated under normal conditions with minimal cleaning.

Will the PetroLimiterator handle emulsified oil?
YES. The PetroLimiterator was specifically designed to treat oils emulsified by detergents or the ship's motion. EnSolve has successfully tested the PetroLimiterator with a number of maritime degreasers and detergents.

Will the system function if pure oil or heavy oil is pumped into the system?
YES. That is why the system is designed in stages. Free-phase oil from Stage 1 is physically separated from water and directed to a waste oil collection tank. The emulsified oil that is not separated in Stage 1 is directed to Stage 2 for biological treatment. This unique one-two punch is what distinguishes our technology from any other.



PetroLimiterator® OWS

USCG and IMO Approved

OIL WATER SEPARATOR



PetroLimiter® OWS

USCG and IMO Approved Oil Water Separator

A complete line of pollution-prevention solutions for bilge water, the PetroLimiter® is a US Coast Guard (USCG) and International Maritime Organization (IMO) approved oily water separator (OWS) that easily handles phase-separated oil, emulsified oil, and water. The system processes oily bilge water and reduces petroleum hydrocarbon concentrations to less than 15 parts per million (*usually below 5 ppm*). Emulsified oil is easily handled by the system, whether caused by detergents and/or the ship's operation.

This automated bio-mechanical system is safe, reliable, and simple to use. Unlike conventional oil water separators, the PetroLimiter actually destroys oil and grease using naturally occurring microbes. This patented technology has been used on ships since 2000 including a variety of platforms such as passenger ferries, oil tankers, ore carriers, oil exploration vessels, cruise ships, off-shore drill rigs, Ro-Ro's, car carriers, and military ships.

The automated system is designed to work unattended 24 hours a day, 7 days a week but can accommodate practically any schedule. Some models can process up to 5,400 gallons ($20 m^3$) per day!

System Operation

The PetroLimiter consists of three distinct stages for removing oil and contaminants from bilge water.

STAGE 1 allows for initial separation and removal of pure oil.

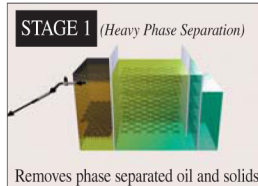

STAGE 2 contains safe, non-pathogenic microorganisms that convert oil, grease, transmission fluid, gasoline, fuel, and other hydrocarbons into harmless end products.



STAGE 3 allows for monitoring and removal of clean effluent.

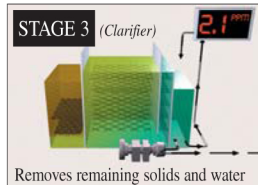

PETROLIMINATOR SYSTEM BENEFITS

The PetroLimiter OWS system combines the latest technology with low maintenance, trouble-free operation. The system's benefits include

- ✓ **Cost Savings:** Reduces offloading, maintenance, and operational costs associated with sludge, spent flocculants, filters and/or bilgewater. Some of our clients saved over 90% per year in operational costs by using the PetroLimiter technology compared with other OWS systems.
- ✓ **Green Technology:** Little or no HAZMAT materials to dispose.
- ✓ **Industry Proven:** The PetroLimiter technology has been employed on ships since 2000.
- ✓ **Processing of Emulsified Oils:** Chemical and mechanical emulsions easily processed.
- ✓ **Added Benefit:** The system can process many biodegradable organic wastes such as antifreeze, solvents, etc.
- ✓ **High Process Rate:** Some PL models can process up to 5,400 gallons of bilgewater per day.

Type Approvals

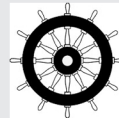

EnSolve®
Biosystems, Inc.

EnSolve Biosystems, Inc.
5805 Departure Dr, Suite B
Raleigh, NC 27616
(919) 954-6196 Fax (919) 954-6197

www.ensolve.com



Clean Seas Ahead!



- ▶ NAG Marine
- ▼ Products
 - ▼ Tank Level Indicators
 - ▼ Environmental Products
 - ▶ Oily Water Separator
 - ▼ Oil Content Monitor
 - ▶ Ballast Water Treatment
 - ▶ Water Treatment Systems
 - ▶ Fluid Monitoring Products
 - ▶ ABS Approved Computers
 - ▶ Military Products
- ▶ Services
- ▶ Installation
- ▶ Careers
- ▶ About
- ▶ Contact

Click the article below to read how a UV Fluorescence Oil Content Monitor can solve your Oily Water Separator problems

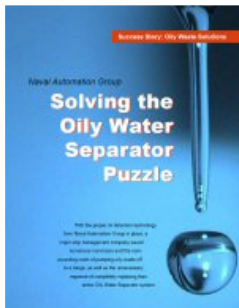

TD-107 Oil Content Monitor Fluorescence Detection Technology



Mouse Over for Larger Image



TD-107 Fluorescence Oil Content Monitor IMO MEPC 107 (49) Certified



The TD-107 Oil Content Monitor is designed with a positive fitting injection port to accept nonhazardous cleaning or calibration solution for the sample cell.



TD-107 Oil Content Monitors includes standard alarm relays, 4-20 mA output for remote monitoring, and a user-friendly USB data port for review of recorded discharge levels prior to port state control visits.

PRODUCT INFORMATION

The TD-107 Fluorescence Oil Content Monitor (OCM) is a 15 ppm bilge alarm for oily water separators based on fluorescence detection technology. Fluorescence occurs when a molecule absorbs light energy of one specific wavelength and emits light energy of a longer wavelength. Fluorescent compounds (such as oil) each have a unique wavelength signature, and these compounds can be detected as an actual concentration of oil in water. Fluorescence makes the TD-107 resistant to interferences by turbidity or particles/sediments in the bilge which impact competing "light scatter" oil content monitors. Because silt / algae / iron oxide and other particles do not fluoresce at oil's wavelength, they cannot interfere as a 'false positive' high alarm that will keep the oily water separator in recirculation mode without ever pumping down the oily waste holding tanks.

The TD-107 Oil Content Monitor is IMO MEPC 107(49) certified and approved by the USCG for use as a 15 or 5 ppm bilge monitor / bilge alarm, with detection capability up to the parts per billion level. It comes equipped with required data logger and can be customized to show system trends. The oil content monitor features self-compensating electronics that corrects for fouling of the sample cell, along with a cell condition monitor to alert crew when sample cell cleaning is required. The TD-107 Fluorescence Oil Content Monitor includes standard alarm relays and 4-20mA output for remote monitoring, along with user-friendly USB data port for review of 23 months of recorded oil content monitor / oily water separator discharge levels over time. The TD-107 Oil Discharge Monitoring Equipment (ODME) is essential for staying in compliance with IMO MEPC 107(49).

Customer Benefits:

- IMO MEPC 107(49) Certified as Oil Content Monitor / 15 ppm Bilge alarm for Oily Water Separators
- USCG approved / ABS approved / NEMA 4X Oil Content Monitor

IMO MEPC 107(49) Specification Sheets

[TD-107 Fluorescence Oil Content Monitor](#) [PDF](#)

Technical Drawings OCM / Bilge alarm

[TD-107 Fluorescence Oil Content Monitor](#) [PDF](#)

Operation Manual - OCM / Bilge alarm

[TD-107 Fluorescence Oil Content Monitor](#) [Contact](#)

Presentation - How does UV Fluorescence work?

[TD-107 Fluorescence Oil Content Monitor](#) [PDF](#)

IMO MEPC 107(49) Type Approvals

[Oil Content Monitor / 15 ppm Bilge Alarm](#) [USCG Approval](#) [PDF](#)
[Oil Content Monitor / 15 ppm Bilge alarm](#) [Other Countries](#) [PDF](#)

Learn more at: www.td107.com

Fluorescence Oil Content Monitor

- Fluorescence unaffected by sediment / particles / turbidity allows Oily Water Separator to work as intended
- Simple and easy maintenance, including an optional 'hot-swap' calibration program

© 2009 NAG, LLC. All Rights Reserved. Privacy Policy & Terms of Use.



Proposal

**For : Great Lake Environmental Center
Doug Endicott**

MyCelx Water Treatment System for removal of hydrocarbons

Proposal Date: 8/6/10

Project No: EPA 10m3/hr 107(49)

Prepared by: MyCelx Technologies Corporation

**Contact: Bob Lawson
lawson@mycelx.com
901-213-1778**

MyCelx Oil Removal Technology

MyCelx Oil Removal Systems - Applications

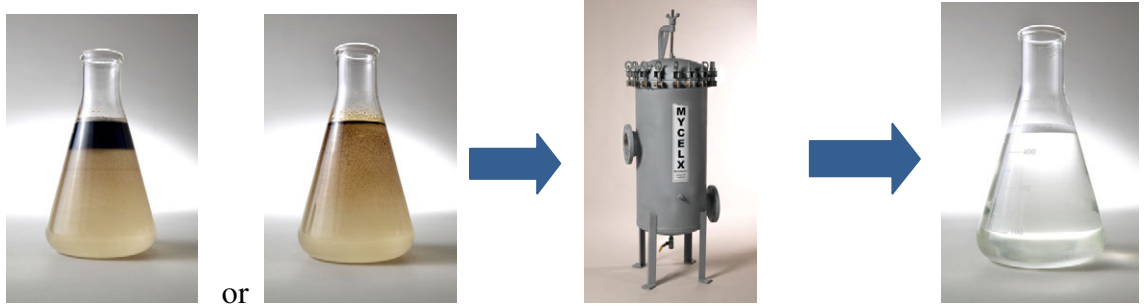
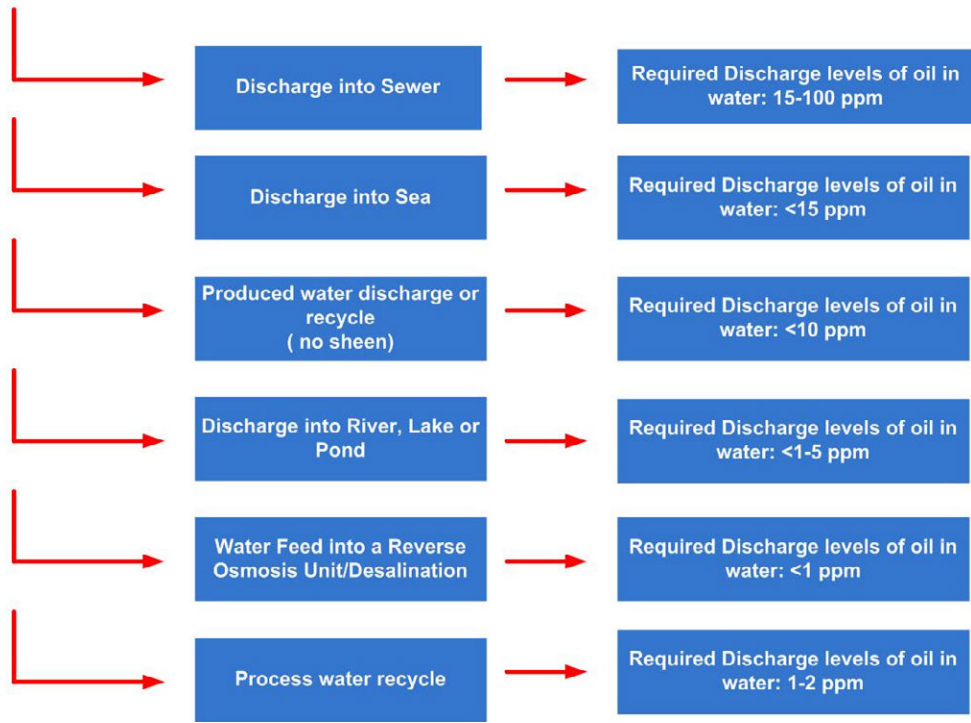

MyCelx Technology offers an effective, robust and economically viable oil removal solution

- Environmentally Green Engineered Oily Water Filtration & Hydrocarbon Odor Removal Solutions
- Patented Molecular, Composition of Matter and Applications
- The only technology certified by Lloyd's Register, UK for oily water treatment and discharge into marine environments
- Deployed and implemented in over 100 installations in major petrochemical, oil & gas, marine, power and utilities, government and military, manufacturing industries.

MyCelx Technology offers the fastest, easiest, most reliable and economically viable solution to oily water filtration for water reuse options

- **Fast** – Small Footprint, Low pressure drop, High Throughput
- **Easy** – Operator Friendly, Low Manpower Requirements, Simple Maintenance
- **Reliable** – Safe, Robust Operation and Process Protection, >99% efficiency
- **Economical** – Lowest capital & competitive operating costs

MyCelx Technology is Green Technology

- Lowest energy consumption
- Smallest footprint and most efficient process for oil contamination removal
- Lowest disposable/recyclable byproducts
- MyCelx Technology utilizes a fully green manufacturing process with 100% conversion of raw products to finished goods

Why choose MyCelx Oil Removal Systems?

- No visible oil sheen guarantee in the effluent
- Instant and permanent oil removal – GRO, DRO and oils (free, dispersed and emulsified)
- Least size and footprint to high oil removal efficiency
- No additional pump requirement – requires less than 1 bar to operate – inline pressure of process water > 1 bar is suffice
- High Oil Removal Capacity (4-10 lbs/filter) –low waste – 1/10-1/100 lower waste of any alternate adsorbent media including GAC
- Fixed Oil Removal Capacity – Effectiveness does not vary with influent concentration
- Simple process - safe and easy to use
- Low handling or maintenance time – no electrical or mechanical moving parts
- Internationally proven and over 500 oil removal installations
- Certified by Lloyds Register to meet low discharge levels in oily water
- ISO 9001: 2000 Certified
- Ability to meet 1 ppm or less on oil removal
- No sludge waste
- No liquid or oily water waste

MyCelx Key Clients List

OIL & GAS E&P OPERATIONS

- Anadarko Petroleum Corporation
- EnCana
- Breitburn Energy
- Petrochina
- Conoco Phillips
- MWH Global
- Williams Pipelines
- Magellan Pipeline
- Enterprise Pipeline Products
- JLC Technologies
- Global Petroleum Research Institute
- CFR Consulting

PETROCHEMICAL & CHEMICAL PROCESSING OPERATIONS

- British Petroleum (BP)
- Saudi Basic Industries Corporation (SABIC)
- Sunoco Chemicals
- Marathon Petroleum
- Bechtel, WSRC
- IBEC
- Nalco Dyes
- Akzo Nobel Pharmaceuticals
- Abbott Labs/ Ross Laboratories

UTILITIES - POWER AND WATER

- United States Army Corp of Engineers
- Pennsylvania Energy Company (PECO)-Utility Co. for Pennsylvania
- Tennessee Valley Authority—Kentucky Hydro Plant
- Allegheny Power
- New York Power Authority
- Niagara Power Authority
- Grand Bahamas Power
- Hawaii Power
- GE Energy
- Vogtle Electric Generating Plaza
- Hydro One –Ontario
- Bechtel WSRC
- Florida Power and Light Company

MANUFACTURING/HEAVY INDUSTRY

- Lockheed Martin
- Jacobs Engineering
- JCM Associates – Constitution Square
- GE Glass – Ecomagination
- DeBeers
- Toyota Motor Corporation
- General Motors Corporation
- Chrysler Motor Corporation
- Honda Automotive Corporation
- United Technologies Corporation (UTC)

MARINE APPLICATIONS

- Wilhelmsen Shipping
- Overseas Shipping Group (OSG)
- Teekay Shipping
- Mediterranean Shipping Company (MSC)
- Dole Ocean Cargo Express
- Eletson Shipping Corporation
- Austal
- BP Shipping
- Matson Navigation
- Barber ship
- United States Coast Guard (USCG)
- United States Navy
- Canadian Coast Guard
- Royal National Lifeboat Institution
- Donjon Salvage
- Disney/ Princess Cruise Lines
- Carnival Cruise Lines
- Galapagos Island Cruise Lines

OIL SPILL REMEDIATION

- State of California - Fish and Game Commission
- Australian Antarctic Division
- Environmental Protection Division – US EPA
- U.S. Steel Corp
- Vogtle Electric Generating Plaza
- Hydro One –Ontario

Process Schematic

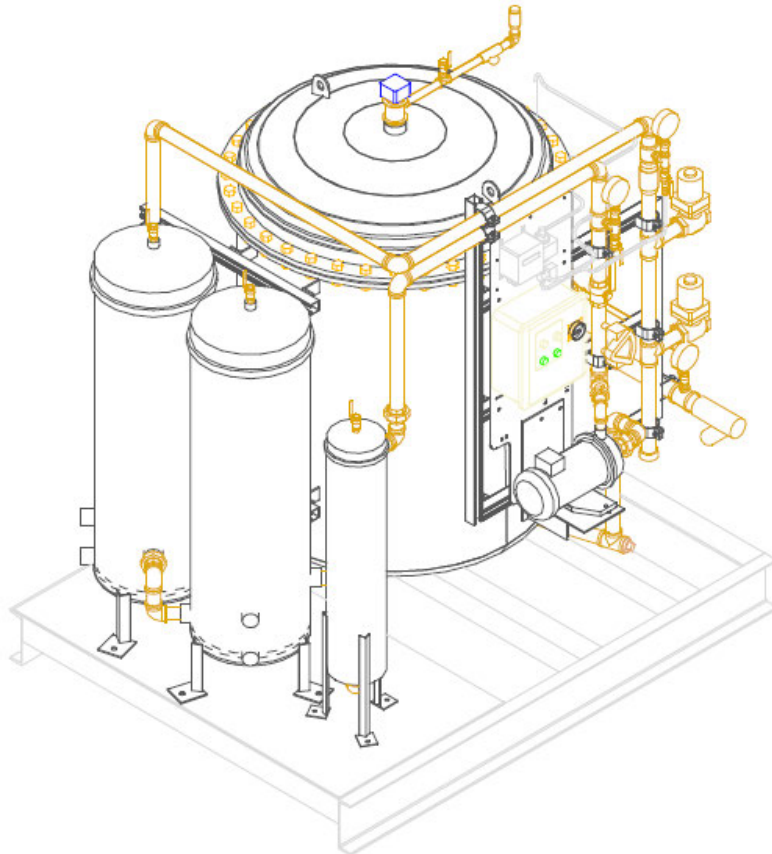

Description:

The BK 107(49) unit will have four stages. The first stage is MyCelx oil water separator with enhanced coalescing media inside. The oil water separator is followed by a bag filter housing on the stage 2. Stage 3 and stage 4 are MyCelx 20 round cartridge filter housing with high efficiency bilge filters on them. Bilge water generated is flown through four stages of MyCelx treatment system and then through OCM which is controls the flow of the treated water. If the OCM reads less than 15 ppm the bilge will be sent for overboard discharge. If the OCM reads more than 5 ppm the bilge water will be directed back to the bilge tank for recirculation.

Picture and Schematic of the Housings in different stages.

Stage -2: Bag Filter Housing

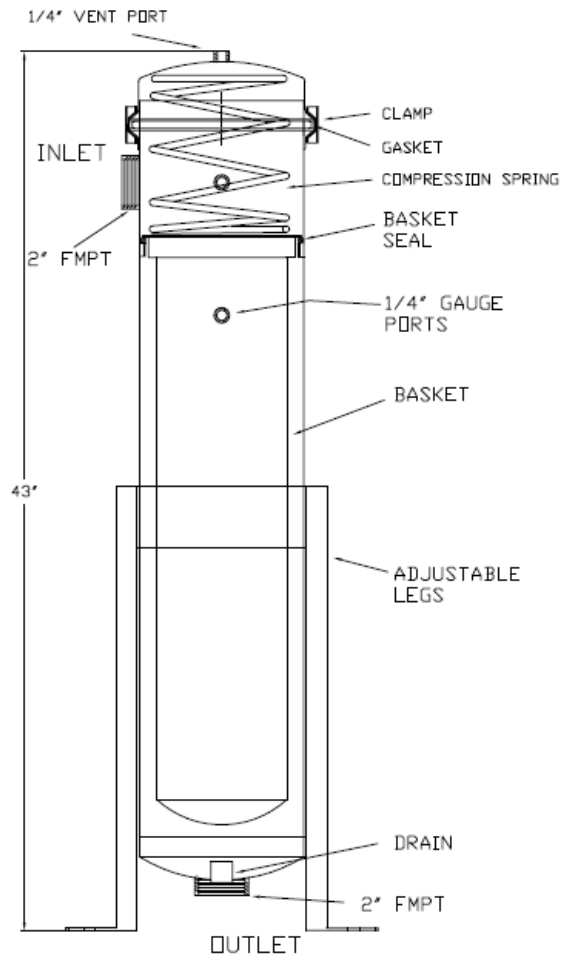

Inlet and outlet connections are 2" NPT

Stage -3 and 4 MX20

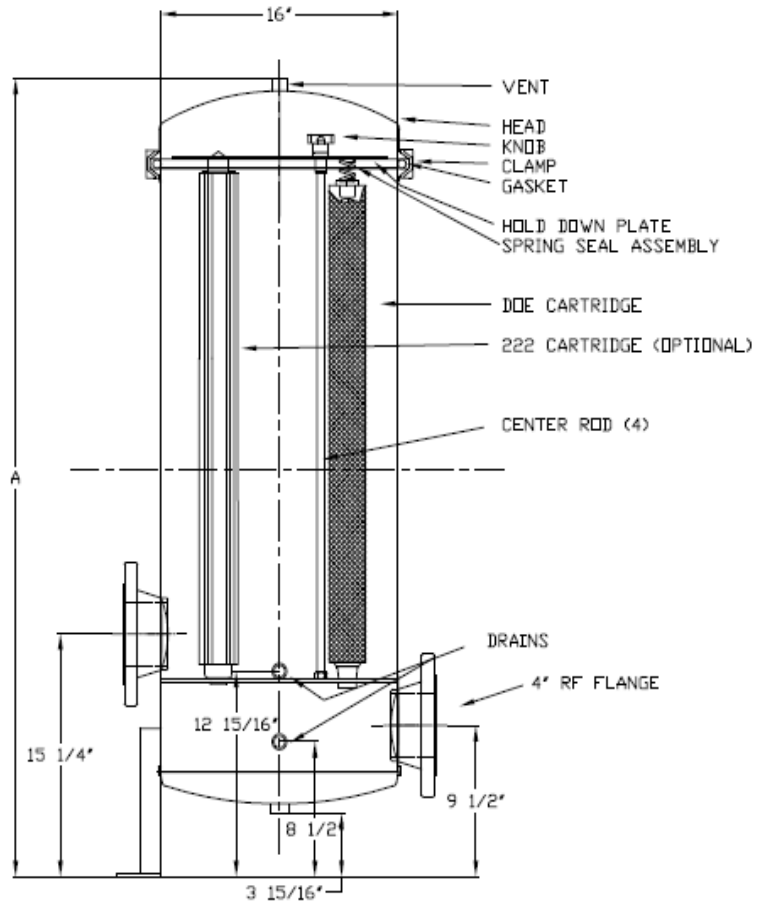

Inlet and outlet are 3" Flange

Design Parameters and Technical Specifications: Table 5

Flow Capacity	10 m3/hr or 44 gpm
Operating Flow Rate	10 m3/hr or 44 gpm
Required Operating Pressure	5 psi
Max. Operating Pressure	150 psig
Max Operating Temperature	180 F
Rating	Non –stamped vessels. Optional ASME stamped vessels are available
Materials of Construction	SS304 Vessels
Drain Ports from 3 filter vessels/housings	½” Brass Ball Valves on Drains Ports
Estimated Maintenance or Media Replacement Period of each Parallel Unit	2- 4 months (depending on the oil loading)
Design Oil in water content in discharge	1-5 ppm

Options requested:

- Left hand design
- High lift option
- float switch
- Differential pressure switches and control panel lights
- Pressure relief valve
- Gasoline resistant pump

MyCelx 107(49) Certified System:



MyCelx 107(49) Certification

	U. S. Department of Homeland Security United States Coast Guard Certificate of Approval
Coast Guard Approval Number: 162.050/A9034/0	Expires: 09 December 2013
OIL POLLUTION PREVENTION EQUIPMENT The following device has been tested in accordance with IMO Resolution MEPC.107(49)	
MYCELX TECHNOLOGIES CORPORATION 470-B Woods Mill Road Gainesville GA 30501	
MyClex 107 - 10.0; 15 ppm Separator	
Equipment manufactured by Recovered Energy Incorporated to specification/assembly drawing no. BOSS 45T 107 dated 5/26/2005. Coalescer manufactured by Recovered Energy Incorporated to specification/assembly drawing no. BOSS 107 Separator System, Rev. A dated 7/7/2005. Filters manufactured by Recovered Energy Incorporated to specification/assembly drawing no. BOSS 107 Separator System, Rev. A dated 7/7/2005. Control equipment manufactured by Recovered Energy Incorporated to specification/assembly drawing no. IMO 107 dated 5/23/2005.	
Maximum throughput of system is 10.2 cu. m/hr (45.0 gpm).	
An integral pump is fitted with this equipment. A copy of this certificate should be carried aboard a vessel fitted with this equipment at all times. IMO Certificates of Type Approval do not expire and are valid for equipment manufactured at any time during the period of validity of this certificate. Test data and results attached in the appendix.	
This certificate documents compliance with 46 CFR 162.050.	
*** END ***	
THIS IS TO CERTIFY THAT the above named manufacturer has submitted to the undersigned satisfactory evidence that the item specified herein complies with the applicable laws and regulations as outlined on the reverse side of this Certificate, and approval is hereby given. This approval shall be in effect until the expiration date hereon unless sooner canceled or suspended by proper authority.	
	GIVEN UNDER MY HAND THIS 9 th DAY OF MARCH 2009, AT WASHINGTON D.C.  T. E. MEYERS Chief, Engineering Division U.S. Coast Guard Marine Safety Center

DEPT. OF HOMELAND SECURITY, USCG, CGHQ-10030
(REV. 3-03)

MyCelx Lloyd's Register Certification Data:

VERIFIED COPY



Lloyd's Register EMEA
71 Fenchurch Street, London, EC3M 4BS
Telephone 020 7423 2940 Fax 020 7397 4246
Email deg-stat@lr.org

Page 4 of 5
Document number SAS P040040
Issue number 2

DESIGN APPRAISAL DOCUMENT

Date 5 October 2004	Quote this reference on all future communications LPA/SSS/POL/SJ
------------------------	---

Tests were conducted using Test Fluid "C" emulsion as specified in IMO Resolution MEPC.107(49), Annex Part 1, at a concentration up to 3000ppm to an effluent oil concentration and flow rate as tabulated below:

TEST NUMBER	SAMPLE DATE	RECEIVED DATE	REPORT DATE	HYDROCARBON INDEX ppm		COLOUR
				Influent	Effluent	
TEST 1 (S2 - S1) 0.5 m ³ /hr	07-Sep-04	13-Sep-04	20-Sep-04	50,000	0.48	No emulsion
TEST 1 (S4 - S3) 0.5 m ³ /hr	07-Sep-04	13-Sep-04	20-Sep-04	100,000	0.14	No emulsion
TEST 1 (S6 - S5) 0.5 m ³ /hr	07-Sep-04	13-Sep-04	20-Sep-04	100,000	0.21	No emulsion
TEST 1 (S8 - S7) 0.5 m ³ /hr	07-Sep-04	13-Sep-04	20-Sep-04	50,000	0.14	No emulsion
TEST 2 (S10 - S9) 1.0 m ³ /hr	07-Sep-04	13-Sep-04	20-Sep-04	50,000	0.37	No emulsion
TEST 3 (S12 - S11) 1.5 m ³ /hr	07-Sep-04	13-Sep-04	20-Sep-04	150,000	0.26	No emulsion
TEST 4 (S14 - S13) 2.5 m ³ /hr	07-Sep-04	13-Sep-04	20-Sep-04	100,000	0.23	No emulsion

TEST NUMBER	PARTICLE COUNT ppm (Effluent)					NAS Class	ISO Code
	6 - 14 microns	14 - 21 microns	21 - 38 microns	38 - 70 microns	> 70 microns		
TEST 1 (S2 - S1) 0.5 m ³ /hr	273156	18867	7689	122	0	11	19/15
TEST 1 (S4 - S3) 0.5 m ³ /hr	279778	7922	2878	11	11	11	19/14
TEST 1 (S6 - S5) 0.5 m ³ /hr	69478	667	344	11	0	9	17/11
TEST 1 (S8 - S7) 0.5 m ³ /hr	135756	2100	711	11	0	10	18/12
TEST 2 (S10 - S9) 1.0 m ³ /hr	198600	1611	267	0	0	10	18/11
TEST 3 (S12 - S11) 1.5 m ³ /hr	276567	5233	1356	11	0	11	19/13
TEST 4 (S14 - S13) 2.5 m ³ /hr	220922	1789	300	11	0	10	18/12

Lloyd's Register North America, Inc.
USA, East Coast
BS
Charleston, SC 

Shipping and Handling Costs:

Components
EX WORKS, Gainesville, Georgia, USA Available as complete skid

Rental Costs:

Item	Components	Price
Housings		
MyCelx BilgeKleen 107(49)	Complete system with oil water separator and MyCelx polisher with Oil content monitor, pump and control valves. Including one set of media installed inside the housings	\$ 45,900.00
Filter Media	(Replacement Set)	
	Total for set of media	\$4,891.00



Coffin World Water Systems

Take the Guesswork Out of Your Bilge Water Separator

ULTRA-SEP™
OILY WATER SEPARATORS

featuring



SPIR-O-LATOR®

Membrane Technology

Can you really count on your Oily Water Separator?



As regulations become more stringent and enforcement increases, everyone, including owners, designers, builders and operators of ships and offshore oil rigs, have become aware that the oily water separator (OWS) is a serious design specification and operating consideration...and a key personal responsibility.

- Are you confident that every drop of water your vessel discharges overboard will meet the strict new International Maritime Organization standards?
- Do your crews spend too much time on OWS maintenance, cleaning, replacing filters, or measuring chemicals?
- Does your system produce hazardous by-products that must be disposed of onshore?
- Do you have worldwide original equipment manufacturer support for OWS service, certification and inspection issues?

Given the high stakes, can you really count on your OWS?

**Now you can. Without fail.
Everywhere. All the time.**

ULTRA-SEP™
OILY WATER SEPARATORS



SPIR-O-LATOR®

Featuring SPIR-O-LATOR® positive physical barrier membrane technology for assured compliance

Drawing on the company's seventy years of marine equipment design and development experience, Coffin World Water Systems (CWWS) continues its leadership in environmental and operational excellence in bilge water separation technology.

ULTRA-SEP continuously discharges bilge water to less than 5 ppm oil content.



Coffin World Water Systems

ULTRA-SEP™ sets the new standard

Unlike other systems that rely on monitors to prevent overboard discharge greater than 15 ppm, ULTRA-SEP is designed to prevent discharge greater than 5 ppm to the monitor or overboard.

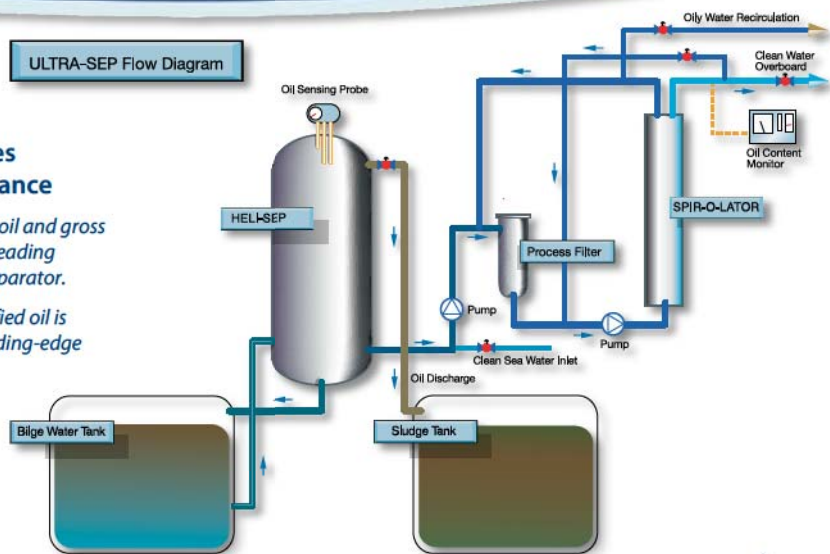

A two-stage system that takes the guesswork out of compliance

The first stage initial separation of free oil and gross particulates is done with our industry-leading HELI-SEP® high efficiency coalescing separator.

The second stage separation of emulsified oil is accomplished with SPIR-O-LATOR® leading-edge membrane technology.

The e⁴ formula for Success

ULTRA-SEP systems with positive physical barrier SPIR-O-LATOR technology surpass all other water separation technologies in meeting the new standards with high efficiency, superior effectiveness, economical operation and assured exposure-reducing performance. This is the e⁴ Formula for Success.



EFFECTIVENESS:

The only system to provide a positive physical barrier

The SPIR-O-LATOR is the industry's most advanced technology to process emulsified oil. It's based on membrane technology, which provides the only positive physical barrier to prevent contaminated water from passing through the system to the monitor.

ECONOMY:

Low maintenance, fewer consumables and no waste disposal

The ULTRA-SEP system results in the lowest total cost of OWS operation by reducing the labor, and entirely eliminating the coalescing filters, media, chemicals, and the hazardous by-products associated with other systems.

EFFICIENCY:

Continuous overboard flow

The SPIR-O-LATOR Membrane provides maximum operational efficiency with minimum labor. A special pore structure rejects oil and dirt at the membrane surface. A self-cleaning flow pattern prolongs operating time between cleanings and provides continuous overboard discharge.

EXPOSURE:

Reduces exposure to regulatory, financial and operational risks

ULTRA-SEP reduces risk exposure with positive physical barrier protection that will not run to failure like many other systems. SPIR-O-LATOR Membrane technology has proven its reliable and superior performance and has been adopted by many of the world's leading fleets.

How ULTRA-SEP™ sets the new standard

Anatomy of the Industry Leader



FIRST STAGE:

High efficiency removal of free oil with HELI-SEP®

The world's leading coalescing matrix separator

The first stage efficiently removes free oils using our HELI-SEP coalescing matrix separator, which is familiar to ship operators worldwide. More than 7,000 units in service around the world is proof of its reliable performance.

- 1** Incoming bilge water is drawn through a high-density permanent matrix providing approximately 242,300 coalescing points with a surface area of 390 square meters per cubic meter of matrix volume.
- 2** Free oil droplets coalesce and rise to the top of the vessel for collection and discharge while particulate impurities settle to the bottom for removal.
- 3** The oil discharge sensor initiates the automated first stage cleaning cycle, cleaning automatically during oil discharge.

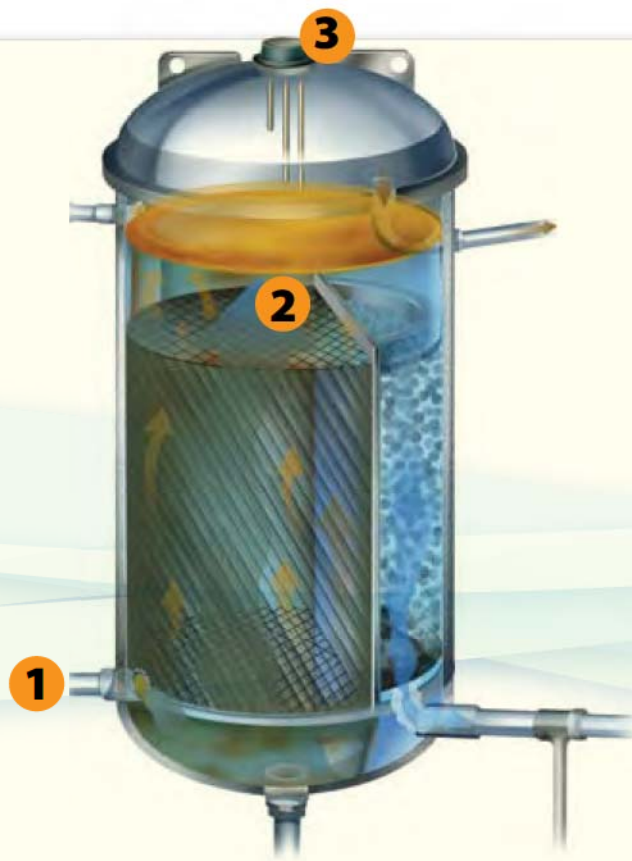

Here's the difference:

ULTRA-SEP™ does not require complicated flocculation chemical regimens or continual dosing, thus saving the cost of chemical supplies and labor!

ULTRA-SEP Membrane technology continuously produces water to a purity of less than 5 ppm oil, while systems based on centrifuges, media or coalescing filters can provide an incomplete separation of emulsified oil under certain conditions.

Unlike other technologies that remove oil from bilge water, leaving an emulsification of varying degrees, SPIR-O-LATOR Membranes remove the water, ensuring safe discharge under the strictest of regulations.

SECOND STAGE:

Superior separation of emulsions with SPIR-O-LATOR® Positive physical barrier membrane technology



A 10 micron oil molecule can't pass through a .01 micron pore. The SPIR-O-LATOR Membrane is the only OWS technology that provides a positive physical barrier against oil and contamination.

SPIR-O-LATOR Membranes reliably and continuously produce clean water with less than 5 ppm oil content. ULTRA-SEP systems are certified to IMO MEPC.107(49) by the U.S. Coast Guard—one of the industry's toughest testing and enforcement agencies.

- 1** Processed water from the first stage is pumped through the second stage at the optimum flow and pressure for SPIR-O-LATOR Membranes.
- 2** The membranes repel oil at the surface and attract water. Their .01 micron pores present a positive physical barrier that rejects oil molecules and particulates while allowing water to pass.
- 3** Water permeating the membranes is clean with less than 5 ppm and can be discharged overboard.
- 4** Concentrated oil waste—the "reject"—is sent to the sludge tank.

How SPIR-O-LATOR[®] technology works

CWWS has been a pioneer in the application of membrane technology to meet the stringent new standards for today's bilge water separation. With more than a decade of operational experience in shoreside and marine applications to separate oily water, the CWWS SPIR-O-LATOR is the most sophisticated and effective OWS technology available for bilge water separation.

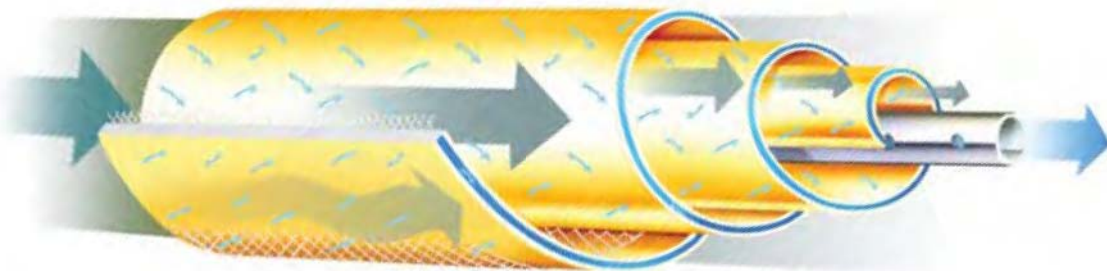

Water is pumped from the outside through the membranes to come out clean through the central core

The unique SPIR-O-LATOR flow continuously pushes bilge water between the layers of membranes. The smaller water molecules are forced into the center of the membranes while the larger molecules of oil remain outside. The two parallel streams of fluids come out the end—clean water in the center, ready to be freely discharged and oily residue on the outside to be removed.

The SPIR-O-LATOR unit contains multiple membrane sheets, spirally wound around a central core (permeate tube). Each sheet consists of oleophobic (oil repelling) outer layers and a hydrophilic (water attracting) central layer to collect the separated clean water. The spiral design provides a large surface area (up to 264 square feet per membrane) for more effective demulsification.

Here's How It Works...

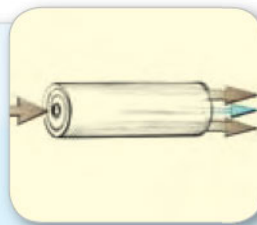

After removal of free oil, bilge water is pumped from one end of the SPIR-O-LATOR to the other, flowing between the sheets of the spirally wrapped membrane.

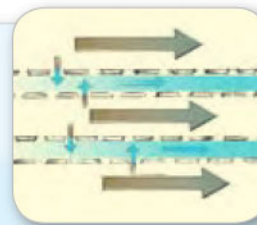

Simultaneously, the bilge water is driven by a pressurized cross-directional flow against the membrane surfaces. The unique spacer design provides flow channel for solids to pass from end to end between membrane sheets without clogging.

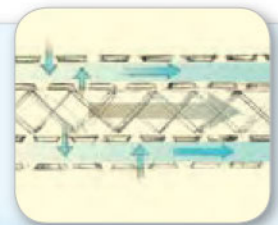

Each membrane sheet has two oleophobic (oil repelling) outer surfaces and a hydrophilic (water attracting) inner layer. This construction repels oil while drawing water molecules into the interior of the membrane.



SPIR-O-LATOR®
Membrane Technology

The unique benefits of SPIR-O-LATOR®

- **Provides a positive physical barrier**

Membranes are the only separation technology that present a positive physical barrier that will not allow oil molecules to pass through to the discharge side of the system. The membrane barrier prevents oil from reaching the oil monitor, which means less cleaning of the monitor, fewer alarms for the crew and minimizes potential for accidental discharge.

- **Cleans in place without clogging**

The SPIR-O-LATOR Membranes' oleophobic surface and asymmetric pore structure result in less fouling by free oils and concentrated oil emulsions. This makes membrane technology the only OWS system that is largely self-cleaning.

- **Has a long operating life**

High oil content in the bilge will not cause a membrane to be spent more quickly, as is the case with adsorption systems, which require regular replacement of filters or media. Simple cleaning in place will allow the membrane to continue in operation without replacement, saving on costs of material, labor and ship downtime.

- **Is not a run to failure technology**

Unlike many other OWS systems which have to be maintained when they channel or become saturated, allowing quantities of oil to pass through to the monitor, SPIR-O-LATOR Membranes operate continuously, preventing oil from reaching the monitor.

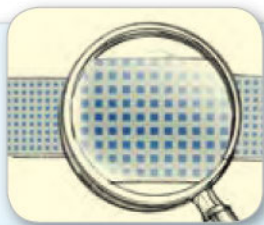

The surface of the membrane presents .01 micron pores through which the bilge water is driven with a 5 bar differential pressure.

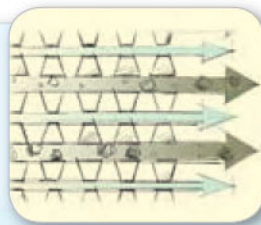

.01 micron pore size accepts entry of water molecules while preventing entry of oil molecules and particulates. The asymmetrical pore structure does not allow oil and particulates to lodge in openings and clog pores.



The water infiltrates into the permeate of the individual laminate sheets that are attached to the permeate tube, and travels through the permeate layer to the tube.

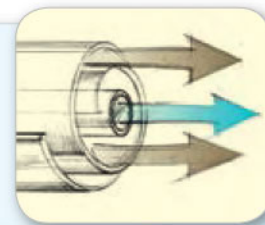

The SPIR-O-LATOR flow continuously pushes bilge water through the membrane pores to produce a central core of clean water that may be freely discharged, and a segregated stream of oily waste that is processed to the sludge tank.

The e⁴ Formula for Success



Evaluating oily water separation technology requires balancing complex factors that influence operational efficiency, the effectiveness of the system under real world conditions, economic considerations, and risk exposure. This is the e⁴ Formula for Success.

EFFECTIVENESS

The effectiveness of a system is dependent on its ability to process the concentration and types of particulates contained in the water, the ability of the system to remove the oil content, and the reliability of the equipment to maintain high performance.

The ULTRA-SEP™ system:

- Provides a positive physical barrier to oil and consistently produces clean water with less than 5 ppm oil content to the monitor and overboard
- Removes particulates along with oil
- Produces clean water without hazardous chemical or biological waste by-products
- Operates continuously without maintenance delays
- Technology is proven worldwide in both shipboard and shoreside installations

EFFICIENCY

OWS systems vary widely in operational factors such as complexity of operation, amount of labor required for daily maintenance, time spent replacing consumables and labor required for environmentally-sound disposal.

The ULTRA-SEP system:

- Requires minimal operator involvement, saving time and labor costs
- Offers PLC (Programmable Logic Controller) with automatic operation and cleaning
- Provides continuous operation and can be cleaned in place
- Continuously processes bilge water, preventing the need for onshore bilge water disposal
- Has control and instrumentation interface kits available for remote monitoring and recording

ECONOMY

OWS systems vary greatly in acquisition and operating costs. The right system can save money in maintenance costs, labor, disposal costs and consumables. An important cost factor is non-operation. Frequent repairs and slow service cause vessel downtime.

The ULTRA-SEP system:

- Is just 20% of the cost of operation per ton compared to other systems
- Does not require chemicals, coalescing filters, clay or carbon filter replacements
- Has a long-lasting membrane life cycle of 5 years
- Produces no chemical sludge that must be disposed of
- Is easy and economical to install
- Provides compact designs

EXPOSURE

Failure of the OWS system puts your business, the environment...and you at risk. In order to mitigate the risk of financial, operational or legal consequences, your OWS system must be easy to operate, economical, effective and provide reliability for the rugged requirements of life at sea.

The ULTRA-SEP system:

- Provides a positive physical barrier that minimizes the risk of accidental overboard discharge
- Is certified by the U.S. Coast Guard (USCG) to MEPC.107(49) and has Marine Equipment Directive (MED) certification
- Is backed by experienced CWWS engineering and service professionals who are available for IOPP, USCG and other port inspections
- Is supported by a worldwide network of parts and service technicians to provide fast response

Comparing OWS Technologies

Any comparison of OWS technology must take into account the actual operation of the system day after day and year after year. How effective is the system? How does it affect your operating efficiency? What does it cost both initially and to keep in proper operation? What is the risk to the ship owners and others in the event of system failure. The chart below provides an overview of how OWS technologies perform in the key value criteria.

OWS Technology



	Coalescing	Adsorption	Flocculation	Centrifuge	Membrane
EFFECTIVENESS					
Continuous separation of chemical and mechanical emulsions	Low	Low	High	Medium	High
Susceptible to permanent clogging	Yes	Yes	No	No	No
Continuous less than 5 ppm effluent to the monitor (all conditions)	No	No	No	No	Yes
EFFICIENCY					
Clean in place	No	No	No	Yes	Yes
Replacement filters required when bacterial fouling occurs	Yes	Yes	Yes*	Yes*	No
Consumable media required for consistent discharge less than 5 ppm	Yes*	Yes	Yes*	Yes*	No
Oil saturation resulting in recirculation	Yes	Yes	Yes	No	No
ECONOMY					
Purchase price	Medium	Low	High	High	Medium
Consumable filtration media	Yes*	Yes	Yes*	Yes*	No
Filtration media disposal cost	Yes	Yes	Yes	Yes	No
Labor involved to clean the unit	Medium	Medium	Medium	Medium	Low
Footprint	Medium	Small	Large	Large	Medium
EXPOSURE					
Effluent consistently less than 5 ppm	No	No	No	No	Yes
Potential for vessel downtime due to inoperable OWS or failed IOPP	Medium	High	Low	Low	Low
Creation of waste for onshore disposal	Yes*	Yes	Yes*	Yes*	No
Positive barrier to prevent oil discharge	No	No	No	No	Yes

* to consistently meet less than 5 ppm.

Whether for new building, retrofit or replacement, ULTRA-SEP™ offers a full range of IMO MEPC.107(49) solutions



ULTRA-SEP Compact



ULTRA-SEP Standard

Unmatched flexibility to get the benefits of ULTRA-SEP anywhere

ULTRA-SEP systems are available in seven models from 0.50 to 10 cubic meters per hour capacity and various power configurations. All models carry U.S. Coast Guard certification to MEPC.107(49) as well as EC Marine Equipment Directive (MED) certification, Russian Maritime Register of Shipping and ABS type approval.

NEW BUILDING – Skid-mounted and Compact ULTRA-SEP units are available up to 10 ton/hour with a variety of pump and motor options to meet your needs. CAD block drawings are available for Naval Architects and Designers as required.

RETROFIT – The ULTRA-SEP MD (Modular-Design) is delivered in modules sized to facilitate access through hatches and fit into tight spaces. Like our skid-mounted models for new builds, the modular-design units come pre-piped and pre-wired for easy assembly and integration with existing connections. Retrofits can be completed while underway without disrupting other activities.

UPGRADE – Technical specification, design, drawing and certified equipment packages are available for upgrade of HELI-SEP installations from MEPC.60(33) to MEPC.107(49) certification. Please consult CWWS Sales and/or Service personnel for more information.

ULTRA-SEP Modular



Specifications for ULTRA-SEP Systems from 0.5 to 10 Cubic Meters per Hour Capacity

Model No.	Capacity		Length*		Width*		Height*		Weight*		Oily Water Inlet		Oil Outlet		Clean Water Inlet		Processed Water Outlet Discharge		Processed Water Outlet Recirculate		Power kW
	m ³ /h	GPM	mm	IN	mm	IN	mm	IN	kg	LBS	mm	IN	mm	IN	mm	IN	mm	IN	mm	IN	
US 500	0.5	2.2	890	35	760	30	1550	61	350	770	25	1.0	25	1.0	25	1.0	25	1.0	25	1.0	3
US 1000	1.0	4.4	965	38	890	35	1550	61	390	858	25	1.0	25	1.0	25	1.0	25	1.0	25	1.0	4
US 2000	2.0	8.8	1830	72	1320	52	1670	66	625	1380	40	1.5	25	1.0	25	1.0	25	1.0	25	1.0	8.6
US 3000	3.0	13.2	1830	72	1320	52	1670	66	690	1525	40	1.5	25	1.0	25	1.0	25	1.0	25	1.0	8.6
US 5000	5.0	22.0	2640	104	1420	56	1880	74	863	1902	50	2.0	25	1.0	25	1.0	25	1.0	25	1.0	8.8
US 7500	7.5	33.0	2640	104	1815	71.5	1995	78.5	1430	3150	50	2.0	25	1.0	25	1.0	50	2.0	50	2.0	12.5
US 10000	10.0	44.0	2640	104	1815	71.5	1995	78.5	1535	3380	50	2.0	25	1.0	25	1.0	50	2.0	50	2.0	12.5

* Approximate dimensions for single skid system.

The system can also be installed in modular skids depending on the space available.

Note: For ships with challenging bilge conditions, CWWS has developed and offers an array of technical solutions from tank design to automated pretreatment.

Worldwide resources to keep your water clean and your environment protected

Coffin World Water Systems (CWWS) serves a global customer base with state of the art separation technology for meeting water discharge regulations, process requirements and water purification standards. We call on our depth of experience, ISO 9001 quality manufacturing and a worldwide network of factory trained engineers to provide solutions that fulfill your requirements for effectiveness, efficiency, economy and the reduction of risk exposure.

TOTAL COMMITMENT

Coffin World Water Systems combines the experience and dedication of two industry powerhouses, World Water Systems and Coffin Turbo Pump, to continue its worldwide leadership role in the marketplace. We are committed to bringing the finest technology, the most experienced professionals and best practices to the critical problem of water treatment and clean discharge into our oceans and waterways.

Our commitment is demonstrated through a company-wide dedication to quality, development of superior products, meeting customer needs, and is backed by expert support, service and comprehensive warranties.

WORLDWIDE FOOTPRINT

Our extensive network of service centers, engineers and trained representatives enables us to provide service, parts, consulting, certification and problem solving worldwide. We know the value of time in critical marine and offshore applications, and we are always available to help you keep your operations up and running wherever they may be around the globe.

CWWS offers a wide range of products to the marine and offshore oil and gas industries. Please see our website www.cworldwater.com to obtain technical information and product brochures for:

- ULTRA-FILTRATION and monitoring solutions for deck wash applications
- AQUA-SEP reverse osmosis fresh water making equipment
- CRP-SEP oily water separators for process water applications on rigs and platforms
- ULTRA-SAFE assured compliance monitoring systems for marine and offshore

DESIGN AND TECHNOLOGICAL LEADERSHIP

Over the past quarter of a century, CWWS has been a leader in environmental and operational excellence in water separation technology.

We combine our extensive knowledge of water treatment, filtration and separation technology with innovative systems engineering and efficient manufacturing techniques to provide our customers with proven and effective solutions for their water generation, fluid separation and wastewater discharge applications.

Our pioneer HELI-SEP® single vessel oily water separator revolutionized the market with its compact footprint, automatic operation and low maintenance requirements. CWWS is now setting new standards in oily water separation with leading edge SPIR-O-LATOR® Membrane technology to provide vastly improved operation and superior results. CWWS was the first OWS manufacturer to be certified by the U.S. Coast Guard in June, 2004, to IMO MEPC.107(49).





COFFIN WORLD WATER SYSTEMS

Leading global innovator in water separation systems

CWWS products, parts and services are available around the world through an extensive network of technical representatives who are factory trained in the application, selection and operation of our products. CWWS representatives offer extensive knowledge and experience in the proper application of our equipment. They are backed by our world leading experts in water applications. Together they will work closely with you to ensure that your installation operates to the highest level of performance and meets your requirements.

Contact your local representative or our corporate offices for more information, technical support or to arrange for a service technician to visit your location. CWWS is a division of Coffin Turbo Pump.

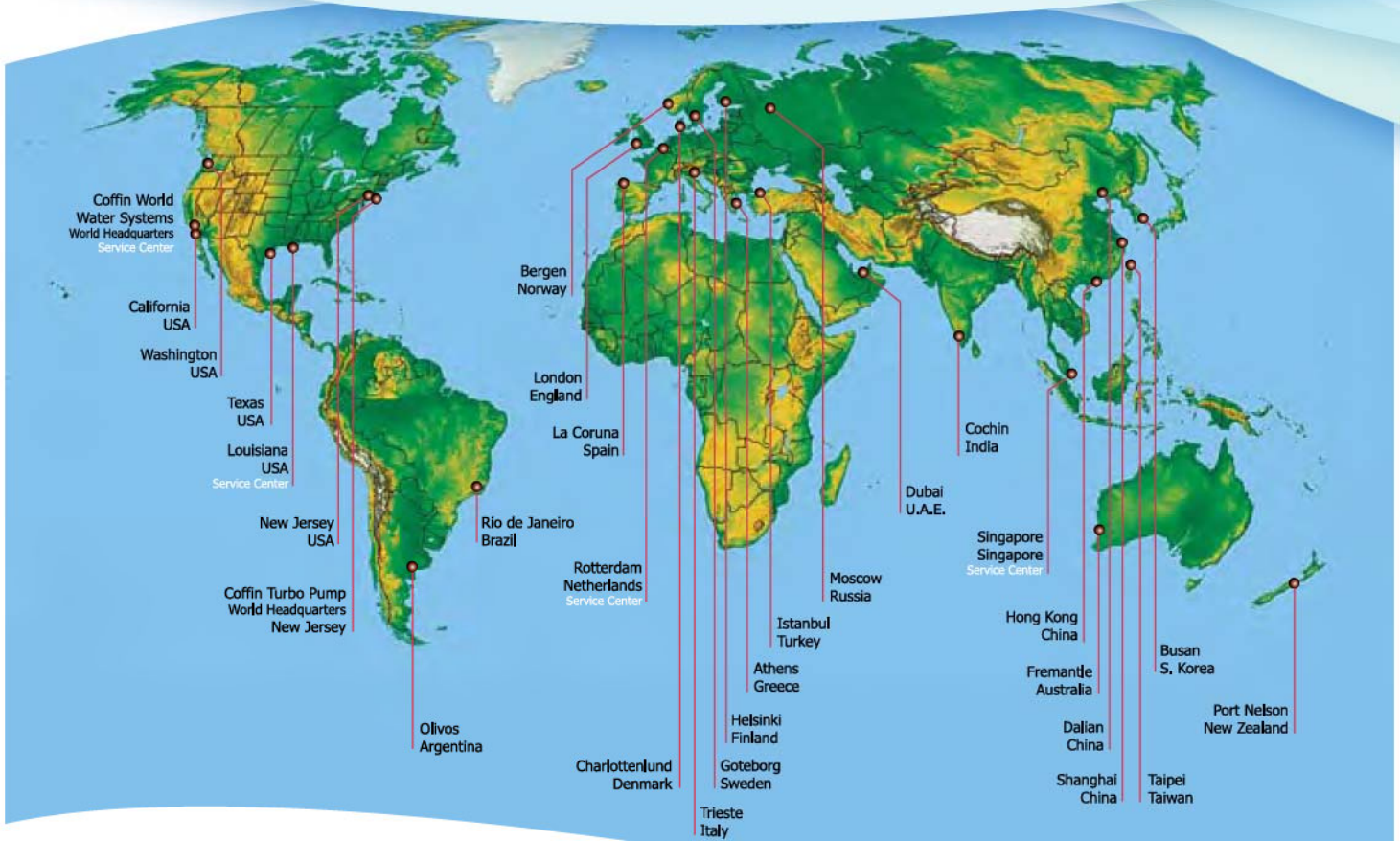

Corporate Headquarters

1732 McGaw Avenue
Irvine, California 92614
U.S.A.

Tel: +1-949-222-5777
Fax: +1-949-222-5770

info@cworldwater.com

European Sales Office

The Gatehouse, 35 Robjohns Road
Chelmsford Essex CM1 3AG
England

Tel: +44 (0) 1245 251711
Fax: +44 (0) 1245 252088

Coffin Turbo Pump

326 South Dean Street
Englewood, New Jersey 07631
U.S.A.

Tel: +1-201-568-4700
Fax: +1-201-568-4716



Coffin World Water Systems

www.cworldwater.com

ATTACHMENT B:

SUMMARIES OF INFORMATION GATHERED IN TELEPHONE CONVERSATIONS

EMAIL RECORD

Project: 6004-21 NPDES Task Order 4, Task 1 Permit Development
Date: September 22, 2010
Company Name: Victor Marine
Contact Name: Antony Chan
Email Address: achan@victormarine.com
Name: Doug Endicott
Subject: Victor Marine Bilge Oil Water Separators

TOPICS DISCUSSED AND ACTION TAKEN

Dear Doug,

With regards to your enquiry here is some information you have requested.

1. Victor Marine OWS units are tested to and compliant to MEPC 107(49). I have enclosed our third party testing of the VM1000 report (which was witnessed by class surveyors and an USCG representative). All results show <1ppm including samples using test fluid 'C'.
2. Capital Cost – Duncan has provided a quotation on the capital cost.
3. O&M costs – There is no back washing or cleaning processes in our system which means there is no downtime and no other processes occurring whilst in operation. The maintenance only includes replacing the filters which is an easy and fast process.

There are two main consumables that the OWS uses. This is the Coalescing Filter Element and the Advanced Granular Media. Both are dependent on the quality of the bilge water that the unit is subjected to. However both are only used if the concentrations of oil and particulate matter are present. Note, If just water is running through, nothing is consumed.

a) Coalescer Element – is not degraded by oils but as it is a filter will need replacement if blinded with solid matter. During IMO testing this item would run continuously as the amount of solid presented is low and no pressure build-up would occur. However in practice, the average replacement time recommended is annually (for new ships) and bi-annually for older ships. The pressure gauge shows when replacement is due, high solid loading shorter replacement time (in this scenario, we recommend a pre-strainer to the OWS system which can be clean periodically to save costs) – cost to replace this item is £165.00 for a VM1000 unit.

b) Advance Granular Media – this section is used to remove emulsified oil in water. In a VM1000, the amount of media is 100kg. Typical adsorption rates are between 40-70% in oil.

Example Calculation (as a guideline):

Taking a typical ship the oily emulsions in bilge are estimated at 150ppm of oil.
For a VM1000, flowrate is 1.0m³/hr, which equates to approx. 0.15kg/hr of oil needed to be removed.
Taking average adsorption rate to be 50% weight = 50kg in a VM1000 unit, we can find the running time of 333hr until the AGM needs to be changed.

The cost of a VM1000 change is £545.00 each. Thus assuming the unit is run 1 hr daily, this would be 1 change per annum.

c) During the service you would require to change the gasket set too. This is £95.00

So total annual cost can be estimated to be £545.00+£165.00+£95.00 = £805.00 per annum or a better calculation would be £2.40 per tonne of bilge water processed.

From our database and experience, we have seen replacement filters/media ordered between 6-18 months.

I hope the above gives you an indication of the unit costs, if you require further information please let us know,

Kind Regards

Antony Chan
Engineering Manager, Victor Marine

From: Duncan Marshall [mailto:dmarsshall@victormarine.com]
Sent: 21 September 2010 12:36
To: denticott@glec.com
Cc: achan@victormarine.com; 'Dennis Day'; 'Peter Barton'
Subject: RE: requesting information for bilge oily water separators

Thank you for your interest in our products and we are pleased to send you copies of our standard quotes for both the CS and VM Oily Water Separators. Both separators use the same technology and processes but as you can see the VM is a much more sophisticated model and therefore is a more expensive unit to manufacture.

The smallest unit we manufacture is a 0.25 m³/hour and the largest is 5 m³/hour we have therefore quoted for both the 0.25 m³/hour and the 1 m³/hour units but should you require the price of any other units please do not hesitate to contact us.

Our Antony Chan will contact you over the next 24 - 48 hours either by e-mail or phone to discuss our equipment further and as the designer of our separators is much more qualified to discuss the equipment than me.

I hope the attachments are of interest and should you have any queries I am sure Antony will be able to answer them.

Kind Regards

Duncan Marshall
Sales Manager

Mob: +44 7932 001497

-----Original Message-----

From: Doug Endicott [mailto:dendicott@glec.com]

Sent: 17 September 2010 13:39

To: info@victormarine.com

Subject: requesting information for bilge oily water separators

Hello,

I am a contractor to the federal EPA, supporting their development of a national Vessel General Permit for non-recreational vessels. Part of this work involves gather information for EPA on the current commercially available onboard treatment systems to remove oil from bilge water. Victor Marine is being contacted because it advertises the VM Series oily water separator certified by IMO MEPC 107(49) for removing oil from bilge water.

I have reviewed the information about the VM Series separators on your company's web site, and have questions to ask as follow-up. This information may be summarized for inclusion in the Administrative Record to support EPA's Vessel General Permit. Specifically:

Can you provide information on capital and O&M costs for treatment systems with capacities of approximately 1 cubic meter per day and 1 cubic meter per hour? Do the O&M costs include service and/or maintenance parts, labor, replacement media, and residuals disposal? If not, are there guidelines for usage rates of these items for in-service treatment systems?

Secondly, can you provide third-party data for oil/hydrocarbon concentrations in the effluent from this treatment system? Is this data for the system treating real bilge water onboard a ship, or is it data from a certification test? In the latter case, I am interested in treatment data for Test Fluid C "emulsified oil" defined under CFR 162.050.

Would it be possible to speak to a company representative about the VM Series separators certified OWS? I can be reached at (231) 941-2230 between 9 and 4:30 EDT.

Thank you,
Doug Endicott
Great Lakes Environmental Center
739 Hastings Road
Traverse City, MI 49686
(231) 941-2230 office
www.glec.com
webpages.charter.net/dougendicott/

9/13/10 TELEPHONE CALL RECORD

Project: 6004-21 NPDES Task Order 4, Task 1 Permit Development

Date: September 13, 2010

Company Name: Seaway Marine Transport

Contact Name: Steve Wright

Phone No.: (swright@seawaymarinetransport.com)

Name: Doug Endicott

Subject: Bilge Oily Water Treatment System

TOPICS DISCUSSED AND ACTION TAKEN

Tobias Mattsson of Alfa Laval suggested I contact Mr. Wright. He is the director of marine projects at Seaway Marine Transport, a Canadian shipper operating 24 freighters on the Great Lakes. Because his company operates vessels on the Great Lakes, they must comply with 5 ppm oil standards for their bilge discharges.

Seaway Marine Transport's primary concerns in choosing bilge separators are that they be effective and reliable. Cost is not so much an issue, because the cost of not complying with the 5 ppm standards would be inevitably greater. Their company has installed centrifuge-based bilge separators (Alfa Laval) on their vessels. This choice was based on the positive reputation of the centrifuges for bilge separation, Alfa Laval's reputation for supporting their products, and the company crew's experience operating and maintaining other centrifuges aboard ship, which are used for fuel treatment and lube oil separation. In fact, most vessels have 3 centrifuges on board. Thus, the crews are familiar with this technology, which is an important consideration. Their Alfa Laval separators are very reliable and routinely produce 0-2 ppm effluent oil concentrations without tertiary (organoclay filter) treatment.

In Mr. Wright's opinion, the centrifuge systems are the best available, although he also indicated that other "top of the market" (i.e., high purchase price) systems (e.g., Marinfloc, Wartsilla) are known to perform well. Lower-cost bilge separators (especially OWS/filter combinations) can also work, but are more sensitive to changing bilge water composition, can require large quantities of consumables (e.g., sorbent media), and can be more difficult to properly maintain.

OCMs are as much trouble to the ships' crews as the separators. They require continuous maintenance and cleaning to avoid malfunctions and erroneous readings due to interferences with the turbidity they monitor. Mr. Wright suspects that more than half of the OCM readings above 5 ppm aboard his vessels are erroneous, which is a problem because (1) it causes the bilge separators to recirculate instead of discharging clean effluent and (2) these readings are recorded and saved for 18 months. The accuracy of the Dekma and Rivertrace OCMs they use is reportedly ± 5 ppm, so their readings are questionable.

Mr. Wright indicated that there is a big difference between meeting a 5 ppm oil standard versus 15 ppm in bilge water discharge, the former requiring much greater effort. Seaway Marine Transport's experience is that meeting 5 ppm oil standards for bilge discharge is possible, although it requires a serious commitment to acquiring and maintaining effective bilge separators and OCMs, along with following guidance such as the IMO Integrated Bilge Water Management

practices. The latter include proper design of bilge water holding tanks (oil skimming within the tanks, suction from the bottom of the tanks, etc.).

I asked Mr. Wright about how his company's vessels handle oil residuals. They do not incinerate oil waste aboard ship in the Great Lakes, although they have considered this as an option. They offload oil waste at the fueling facilities that they use, one being at Hamilton, Ontario. Common charges for oil waste disposal are Can\$ 0.13-14/liter (this is equivalent to \$ 0.48-51/gallon).

TELEPHONE CALL RECORD

Project: 6004-21 NPDES Task Order 4, Task 1 Permit Development

Date: August 26, 2010

Company Name: Alfa Laval

Contact Name: Larry Bogia

Phone No.: (267) 980-1779

Name: Doug Endicott

Subject: Bilge Oily Water Treatment System

TOPICS DISCUSSED AND ACTION TAKEN

Larry Bogia is the US marine sales manager with Alfa Laval, a company that markets centrifuge-based bilge oily water treatment systems. According to information on the company's web site (www.alfalaval.com), the Alfa Laval product line includes bilge oil separators that are Coast Guard certified for MEPC 107(49). I confirmed this with Larry. He told me that the company's Ecostream bilge treatment system had recently been redesigned to increase capacity. He has visited 100 vessels in the past year where this system has been installed. Although the Ecostream system is 3 times more expensive (purchase cost) than certified units from other manufacturers, he believes that the Ecostream gives superior performance. The Ecostream system currently costs 75,000 Euros, over \$100,000 in the US.

He was aware of company data showing Ecostream systems producing effluent oil concentrations less than 3 ppm for entire deployments. When asked about certification test data, Larry mentioned that their older data had relatively high effluent oil concentrations (~14 ppm) because Alfa Laval did not use a free oil sensor to bypass the treatment system if fed pure oil (as occurs in one of the certification tests). Other manufacturers' systems typically include such a sensor and bypass, and the newer Alfa Laval systems do as well.

Larry indicated that oil content meters (OCMs) was another area where real improvements could be made. The best units, costing over \$30,000, are much more accurate than the low-cost OCMs that are in wide use.

He suggested that I contact Tobias Mattsson in Sweden to obtain the latest certification test data.

TELEPHONE CALL RECORD

Project: 6004-21 NPDES Task Order 4, Task 1 Permit Development

Date: September 1, 2010

Company Name: Coffin World Water Systems

Contact Name: Lou Muzzarone

Phone No.: (800) 568-9798

Name: Doug Endicott

Subject: ULTRASEP Bilge Oil Water Separators (follow-up)

TOPICS DISCUSSED AND ACTION TAKEN

Follow-up conversation with Lou Muzzarone to better understand the issue of waste residuals generated by bilge oily water separators. Lou expressed that the best bilge separator treatment systems achieve both treatment effectiveness (low effluent oil) and operating economy (less oily waste requiring disposal) by removing more of the water from the bilge water. 500 ppm is only 0.5% oil in bilge water, a fairly small volume if most of the water can be removed.

Liquid residuals from bilge separators most often end up in the sludge tanks aboard vessels. When full, these must be pumped ashore for treatment and disposal as oily waste classification (distinct from hazardous waste). Disposal costs vary by port, may be as high as \$1-2 per gallon.

The economic justification for bilge treatment is to reduce the volume of oily bilge water that must be stored aboard the vessel. For vessels <400 GT, the assumption is that these vessels make frequent port calls & therefore can store oily ballast water to be pumped ashore for treatment and disposal.

Solid phase residuals (sorbents) disposal is more ambiguous. Probably treated similar to oily rags, disposal by landfill or incineration on shore. GAC becomes saturated when oil reaches 10-20% by weight.

Residuals from coagulation/flocculation (sludge) probably go to vessel's sludge tank.

The concentrate generated by UF is recirculated to the bilge tank, with most of the oil de-emulsified. The OWS should separate this oil on the next treatment pass. Thus, the overall waste oil generated in a OWS/UF system should be only ~15% of the treated bilge water.

UF membrane lifetime is expected to be 5 years; Coffin warranties membranes for 3 years. Membrane replacement not included in O&M costs he provided previously. Lou promised to provide this cost in the near future.

Oil and hydrocarbons typically do not occur as molecules in water; (large) macromolecules instead.

TELEPHONE CALL RECORD

Project: 6004-21 NPDES Task Order 4, Task 1 Permit Development

Date: August 10, 2010

Company Name: MyCelx

Contact Name: Bob Lawson

Phone No.: (901) 213-1778

Name: Doug Endicott

Subject: Bilge Oil Water Separators

TOPICS DISCUSSED AND ACTION TAKEN

Bob Lawson is sales manager at MyCelx, a company that markets bilge water treatment systems. These systems use a series of treatment steps including coalescence, strainer/prefilter and a polypropylene filter treated with a proprietary polymer (MyCelx). These treatment systems are certified to comply with MEPC 107(49), and are the only certified systems that use filtration. The company also supplies MyCelx filters to other manufacturers of bilge water treatment systems.

He indicated that many MEPC 107(49) certified treatment systems did work well when treating bilge water containing emulsified oil. Some membrane treatment systems use MyCelx filters as pretreatment. MyCelx filters are used to polish bilge effluent on OSG (a US shipper) vessels, and have been evaluated for use on smaller vessels by NOAA and the Coast Guard.

Bob provided several emails with additional information about Coast Guard certification test results and cost data. Copies of these emails are attached (below).

From: Bob Lawson <lawson@mycelx.com>
To: Doug Endicott <dendicott@glec.com>
Subject: MyCelx BilgeKleen Systems
Date: Thu, 5 Aug 2010 11:01:38 -0500

Doug,

This is the Lloyd's certification for our bilge polishing filters. The attached letter from Lloyd's allows these filters to be added to an MEPC 60(33) certified system (this was the only certification available at that time).

Best regards,

Bob Lawson
Sales Manager
901-213-1778
lawson@mycelx.com

From: Bob Lawson <lawson@mycelx.com>
To: Doug Endicott <dendicott@glec.com>
Subject: FW: Bilge Treatment Oversight
Date: Thu, 5 Aug 2010 11:17:06 -0500
Organization: MyCelx

Doug,

This attachment gives an oversight of our range of bilge treatment systems:

- MEPC 107(49) certified OWS for vessels over 400GT
- Sub 5 polishing filters to be added to MEPC 107(49) or 60(33) certified OWS to achieve discharge levels > 5 ppm O&G.
- Mycelx bilge filters to be used on commercial and recreational vessels without OWS systems.

Best regards,

Bob Lawson
Sales Manager
901-213-1778
lawson@mycelx.com

From: Bob Lawson <lawson@mycelx.com>
To: "Doug Endicott" <dendicott@glec.com>
References: <[006801cb34b9\\$a68c5580\\$f3a50080\\$@com](mailto:006801cb34b9$a68c5580$f3a50080$@com)> <[00aa01cb34c0\\$161ac750\\$6932a8c0@glec.local](mailto:00aa01cb34c0$161ac750$6932a8c0@glec.local)>
<[002e01cb3590\\$004ed440\\$00ec7cc0\\$@com](mailto:002e01cb3590$004ed440$00ec7cc0$@com)> <[00aa01cb3591\\$11fc430\\$6932a8c0@glec.local](mailto:00aa01cb3591$11fc430$6932a8c0@glec.local)>
In-Reply-To: <[00aa01cb3591\\$11fc430\\$6932a8c0@glec.local](mailto:00aa01cb3591$11fc430$6932a8c0@glec.local)>
Subject: RE: Bilge Treatment Oversight

Doug,

Re: Big Blue Bilge Filter System

This is a very inexpensive bilge water treatment system used on commercial vessels that do not have an OWS. The system consists of two plastic OC3 filters housing operated in series to achieve a discharge of < 5ppm. This system has a built in visual indicator to let you know when to change filters. The second filter housing has a clear bowl. When the first filter is saturated with oily hydrocarbons it begins to pass small quantities of oil. Since the flow direction through the filters is outside-in, the passed oil from the first filter will show up on the outside of the second filter cartridge. At the next convenient opportunity the first filter cartridge should be discarded and the second filter cartridge moved up to the front. A new cartridge is place in the second position.

This system is rated up to 20 gpm, but two systems (4 housings) can be connected in parallel for flows up to 40 gpm. We have a tour boat in the Galapagos Islands with a bilge system of 80 gpm that has 4 systems piped in parallel.

This is still a comparably compact and inexpensive system (pictures available).

As I mentioned, NOAA recently installed MyCelx big blue bilge systems on their fleet of vessels. I have attached a press release that was issued with NOAAs cooperation and a picture of one of the vessels.

The pricing on a two housing system is as follows:

MyCelx Big Blue Bilge System Max. flow rate 22 GPM

OC3 (4.5x20") white	\$134.00	incl. filter cartridge and mounting bracket
OCC3 (4.5x 20") clear	<u>\$175.00</u>	incl. filter cartridge and mounting bracket
Total	<u>\$309.00</u>	

Replacement cartridges MD20LD5-5 \$405.00 per case of 5

Best regards,

Bob Lawson
Sales Manager
901-213-1778
lawson@mycelx.com

From: Doug Endicott [<mailto:dendicott@glec.com>]
Sent: Friday, August 06, 2010 12:59 PM

To: Bob Lawson
Subject: Re: Bilge Treatment Oversight

For the sake of comparability with other OWS systems, probably the PureShip BilgeKleen MEPC 107(49) 1.0 and 10 m3/hr are the most appropriate. If you have cost data for the smaller "Big Blue" systems, I will use that as well. I think EPA is considering what to do about vessels < 40 tons.

----- Original Message -----

From: [Bob Lawson](#)
To: [Doug Endicott](#)
Sent: Friday, August 06, 2010 1:51 PM
Subject: RE: Bilge Treatment Oversight

Do you have any specific systems or applications that you would like pricing on?

From: Doug Endicott [mailto:dendicott@glec.com]
Sent: Thursday, August 05, 2010 12:03 PM
To: Bob Lawson
Subject: Re: Bilge Treatment Oversight

Thank you, Bob. I will review this material for inclusion in the technical report I'm preparing for EPA. Were there any cost data you could share with me regarding the capitol and O&M costs of the integrated OWS/MYCELX systems?

Doug
----- Original Message -----

From: [Bob Lawson](#)
To: [Doug Endicott](#)
Sent: Thursday, August 05, 2010 12:17 PM
Subject: FW: Bilge Treatment Oversight

Doug,

This attachment gives an oversight of our range of bilge treatment systems:

- MEPC 107(49) certified OWS for vessels over 400GT
- Sub 5 polishing filters to be added to MEPC 107(49) or 60(33) certified OWS to achieve discharge levels > 5 ppm O&G.
- Mycelx bilge filters to be used on commercial and recreational vessels without OWS systems.

Best regards,

Bob Lawson
Sales Manager
901-213-1778
lawson@mycelx.com

From: Bob Lawson <lawson@mycelx.com>
To: "Doug Endicott" <dendicott@glec.com>
Subject: MyCelx 107 (49) 1.0
Date: Fri, 6 Aug 2010 14:39:45 -0500
Organization: MyCelx

Price: MyC 107 (49) 1.0 m3/hr \$13,350
Replacement media \$453

Best regards,

Bob Lawson
Sales Manager
901-213-1778
lawson@mycelx.com

TELEPHONE CALL RECORD

Project: 6004-21 NPDES Task Order 4, Task 1 Permit Development

Date: September 23, 2010

Company Name: Total Marine Solutions

Contact Name: Caroline Medich

Phone No.: (954) 327-2032

Name: Doug Endicott

Subject: Bilge Oily Water Treatment System

TOPICS DISCUSSED AND ACTION TAKEN

Caroline Medich is managing director with Total Marine Solutions, the US representative for Marinfloc bilge oily water treatment systems. Marinfloc markets the EBBWCS Type CD oily water separator, which is certified by IMO MEPC 107(49) for removing oil from bilge water. Much information about this treatment system is available on the Marinfloc web site (www.marinfloc.com). The type CD separators operate continuously and have multiple treatment stages: a “descaler” that operates somewhat analogously to a centrifuge (except without moving parts) to remove primarily free oil; a reactor that combines coagulation and flocculation with flotation and skimming of emulsified oil; filtration using Aqualite (volcanic rock) to remove any residual flocs; and activated carbon polishing as a final stage.

Marinefloc publishes list prices for its separators, although Ms. Medich indicated that lower costs are often negotiated. Marinefloc also publishes an operating cost of \$3/cubic meter (\$11/1,000 gallons), which includes replacement parts, chemicals, media and labor. It was unclear whether this operating cost included residual disposal. Filter media and GAC are steam regenerated, and (at most) require annual replacement.

Residual generation has been highly optimized in the Marinfloc type CD separators, and is estimated to be 3-5% of the volume of bilge water treated, although this depends upon how much oil and solids is in the bilge water. Aboard some ships, the crews are very diligent about keeping oil out of bilge water, while on other ships no such effort is made and the bilge separator faces a heavier oil loading. Managing solids/sludge in the bilge water is a similar issue. Ms. Medich noted that many low cost OWS require frequent cleaning because they become plugged by solids. This can become a maintenance problem, especially if the ship’s crew is not properly trained in proper cleaning procedures.

I requested certification data for effluent oil concentrations, as well as “case study” data from separators aboard ships in service. Ms. Medich promised to send available data of this sort in several days. She also noted that Marinfloc is unique in that it guarantees their type CD separators to produce a bilge effluent with oil concentrations below 5 ppm. In her experience, effluent oil concentrations are usually 1-2 ppm.

EMAIL RECORD

Project: 6004-21 NPDES Task Order 4, Task 1 Permit Development

Date: September 1, 2010

Company Name: Alfa Laval

Contact Name: Tobias Mattsson

Email Address: tobias.mattsson@alfalaval.com

Name: Doug Endicott

Subject: Alfa Laval Bilge Oil Water Separators

TOPICS DISCUSSED AND ACTION TAKEN

Doug,

No, you must have got that wrong. It is not that bad. Our high speed separator is designed to clean the water so the oil being pumped out from the oil outlet will not be perfectly pure. In general the water content in the oil will not be more than 10% regardless of if an emulsion is present or not. We use heat and the XLrator in combination of approx 7000 G to break emulsions.

PureBilge is still not a magic machine which will perform perfectly in all circumstances but it is far better than most other available equipment. There are some other good performing OWS's on the market also and they have more or less the same price tag as our system. Our two main competitors in the high-end market is Marinfloc (chemical and filter based) and Westfalia (also high speed separator) but we have so far never lost when ship owners are comparing the performance in real life onboard.

I think the IMO-guideline implementation of IBTS is a good initiative. That will help increase the performance on any OWS and hopefully avoid some of the worst problems the crews onboard are facing.

Alfa Laval also have a sludge separator to treat the oily sludge onboard and dewater the oil so it can be safely incinerated, used a boiler fuel or simply reduce the sludge volumes so it will be cheaper to land it ashore. The oily sludge contains mainly water but also a lot of oil and particles. The water from the sludge separator is pumped to the bilge holding where the OWS will de-oil the water further down to legal limits for discharge overboard. The oil from the sludge separator contains around 1% of water. In a perfect world I would like a sludge de-watering separator to be included in the IBTS.

I more than happy to help you with your work so please don't hesitate to contact me. I'm trying to keep to facts and am avoiding the sales angles. I've been working onboard myself and know how much the crews are struggling with the oily water treatment. Most oily waste equipment is really sub-standard and shouldn't be onboard. I think we have the same goal; avoid oil pollution from vessels and ease the workload for oily water treatment for the crews.

BR's
Tobias

Tobias Mattsson, B.Sc. Marine Eng.
Application Manager Oil Treatment, Parts & Service Equipment
Tel direct: +46 8 530 653 29 - Mobile: +46 708 99 53 29 - Fax: +46 8 530 651 64
tobias.mattsson@alfalaval.com

Alfa Laval Tumba AB

Visit: Hans Stahles väg 7 - SE-147 80 Tumba
Registration number: 556021-3893 - Registered office: Tumba
Tel switchboard: +46 8 530 650 00 - Fax switchboard: +46 8 530 650 55
www.alfalaval.com

This e-mail is intended solely for the use of the individual or entity to whom it is addressed and its content shall be regarded as confidential unless explicitly stated otherwise. If you have received this e-mail by mistake, please notify the sender immediately by e-mail and delete this e-mail from your system.

From: "Doug Endicott" <dendicott@glec.com>
To: "Tobias Mattsson" <tobias.mattsson@alfalaval.com>
Date: 2010-09-01 20:31
Subject: Re: requesting information about bilge oily water treatment systems

Tobias,

Thank you again for your willingness to provide information about your centrifugal separators. When we spoke last week, I recall that you mentioned that the oil separated by the centrifuge typically had a water content of about 50%, but I cannot find this recorded in my notes or in the literature. Is this correct? Or does this vary in practice, for example with the proportion of emulsified oil being treated?

Thanks again,
Doug

--

Douglas Endicott
Great Lakes Environmental Center
739 Hastings Road
Traverse City, MI 49686
(231) 941-2230 office
www.glec.com
webpages.charter.net/dougendicott/

EMAIL RECORD

Project: 6004-21 NPDES Task Order 4, Task 1 Permit Development

Date: August 6, 2010

Company Name: Government of Canada

Contact Name: Paul Topping

Phone No.: (paul.topping@tc.gc.ca)

Name: Doug Endicott

Subject: Canadian Regulation of Bilge Oily Water Treatment System

COPY OF TEXT FROM EMAIL EXCHANGE

Hi Doug,

I had a conversation with my predecessor who was involved with setting the 5ppm limit. Our regulations require a 15 ppm oil filtering equipment with a 5 ppm oil content meter, alarm and automatic stopping device if a vessel is to discharge bilge water from its machinery space into inland waters (such as the Great Lakes and the Seaway). The fitting of such equipment is, however, not mandatory as a vessel has the option of retaining oily bilge water on board for discharge ashore, or in the case of an ocean going vessel, discharging 15 ppm oily water into the sea after it leaves inland waters.

When the 5 ppm option was first introduced in our regulations, there was a requirement to have both approved 5 ppm oil filtering equipment and a 5 ppm oil content meter, but this didn't work as foreign administrations were only approving 15 ppm oil filtering equipment. In the case of the oil content meter, the only concern with using a 15 ppm meter is that the meter must also be adjusted to 5 ppm and then be accurate in the 5 ppm range. If the 15 ppm oil filtering equipment is not producing an effluent that is at 5 ppm or below, then the automatic stopping device will prevent any of the effluent from being discharged overboard. The systems work by fitting a y-valve that diverts any non-compliant effluent back to the oil filtering equipment to be reprocessed so that, unless there is a large influx of new unprocessed oily bilge water, eventually the 15 ppm oil filtering equipment should be able to produce an effluent under 5 ppm. If it can't, then the options of discharging ashore or at sea as mentioned above are available.

With respect to which technologies meet this standard, all the equipment that we have approved is listed in our Approved Products Catalogue at:

http://www.wapps2.tc.gc.ca/Saf-Sec-Sur/4/APCI-ICPA/en/APCI_SelectApprovedPollutionPreventionEquipment.asp?cat=APPE

On the above page in the middle selection "Search by Function:", select CBA (Canadian Bilge Alarm 5ppm) this will provide a list of available products.

Cheers

Paul

----- Original Message -----

From: Doug Endicott <dendicott@glec.com>

To: Topping, Paul

Cc: Albert.Ryan@epamail.epa.gov <Albert.Ryan@epamail.epa.gov>

Sent: Tue Jul 27 14:23:09 2010

Subject: Re: Canadian Oily Water Separator Contact

Hello Paul,

As you point out below, Canada limits the bilge discharge of oil and grease at 5 ppm in inland waters. We are interested in this because it suggests that Canada may have some experience (and hopefully data) regarding whether oily water separator and filtration technologies can meet the 5 ppm limit in practice. My reading of the Canada Shipping Act suggests that the 5 ppm limit actually applies to the bilge alarm and automatic stop, not the filtering equipment itself. The filtering equipment appears to require certification for achieving a 15 ppm effluent, consistent with MARPOL. Maybe you can clarify how the pollution regulations apply in practice, and whether the 5 ppm limit can be achieved by currently available treatment technologies (and, if so, which ones)?

Thank you for your assistance,
Douglas Endicott
Great Lakes Environmental Center
739 Hastings Road
Traverse City, MI 49686
(231) 941-2230 office
www.glec.com
webpages.charter.net/dougendicott/

Topping, Paul wrote:

> Hello Ryan

>

> Things are going well, the weather is fine here. A few days with
> humidity, but nothing like Washington. You have my sympathies.

>

> I can assist Doug as I administer our pollution regulations for ships,
> a link to which is found below.

> <http://laws.justice.gc.ca/en/showtdm/cr/SOR-2007-86>

>

> We have three regimes in Canada depending on where one's ship is
> located.

>

> (1) Coastal waters -east and west, south of 60°N, we set a 15ppm
> discharge limit per Annex I to the MARPOL Convention.

>

> (2) Great Lakes and Seaway east of Montreal -5ppm limit

>

> (3) Artic waters (all Canadian waters north of 60°) zero discharge.
> This is under the Arctic Waters Pollution Prevention Act
> <http://laws.justice.gc.ca/eng/A-12/index.html>

>
> Cheers,

>
>
> Paul

>
>
>

> -----Original Message-----

> From: Albert.Ryan@epamail.epa.gov [<mailto:Albert.Ryan@epamail.epa.gov>]
> Sent: Tuesday, July 27, 2010 12:31 PM
> To: Topping, Paul
> Cc: Doug Endicott
> Subject: Canadian Oily Water Separator Contact

>
>

> Hello Paul,

>

> I hope you are enjoying your summer and not facing a scorcher like we
> have in DC.

>

> Doug Endicott, cc'd in this email, is currently doing some background
> research for us looking at oily-water separator technologies. Would
> you have a good contact in either Transport Canada or another
> department that Doug can contact to assist in his research. The
> questions are merely factual background and searching for good quality
> OWS discharge data.

>

> Many thanks,
> Ryan

>

> Ryan Albert, Ph.D.
> Environmental Scientist
> EPA EAST-Room 7329B Mail Code: 4203M
> 1200 Pennsylvania Ave., N.W.
> Washington DC 20460
> (202) 564-0763

EMAIL RECORD

Project: 6004-21 NPDES Task Order 4, Task 1 Permit Development
Date: September 1, 2010
Company Name: Wartsila
Contact Name: T. Nielsen
Phone No.: (tommy.Nielsen@wartsila.com)
Name: Doug Endicott
Subject: Bilge Oily Water Treatment System

COPY OF TEXT FROM EMAIL EXCHANGE

From: Nielsen, Tommy (Wärtsilä Senitec)
Sent: 30 August 2010 9:29
To: 'dendicott@glec.com'
Subject: Inquiry from public website: Sustainability & Environment

Regarding the oil in the discharged water

I have attached some test results where we have measured the oil content during the USCG test, after start up and after two years in operation. I have also attached the 5 ppm type approval certificate.

Regarding the cost:

We have collected customer feedback to get real figures of the Cost per m³ discharged for our M-Series. The average cost are 3,5 US\$/m³ based on this survey (se below what was measured in the survey).

- * Chemicals consumption
- * Filter material consumption (sand and activated carbon)
- * Power consumption (unit)
- * Power consumption (preheating)
- * Spares consumed
- * Man-hours used for maintenance
- * Attendance requirement for operation

Note that the highest cost for the customer often is the sludge disposal cost. With a bilge water system that works the sludge disposal cost are minimized. We try to point out to our customers

that reduced cost and environmental improvements goes hand in hand and can be achieved by improvement of the sludge and bilge management.

Best regards

Tommy

ATTACHMENT C:
VENDOR SUBMITTED PERFORMANCE DATA

System & Data Type	Testing Type	Test Fluid	Analyte	Effluent Result (ppm)
System D - Certification	IMO Res. MEPC.107(49)	Test Fluid A	Hydrocarbon Oil Index	4.5
System D - Certification	IMO Res. MEPC.107(49)	Test Fluid A	Hydrocarbon Oil Index	4.5
System D - Certification	IMO Res. MEPC.107(49)	Test Fluid A	Hydrocarbon Oil Index	4.5
System D - Certification	IMO Res. MEPC.107(49)	Test Fluid A	Hydrocarbon Oil Index	4.0
System D - Certification	IMO Res. MEPC.107(49)	Test Fluid A	Hydrocarbon Oil Index	4.0
System D - Certification	IMO Res. MEPC.107(49)	Test Fluid A	Hydrocarbon Oil Index	4.5
System D - Certification	IMO Res. MEPC.107(49)	Test Fluid A	Hydrocarbon Oil Index	3.5
System D - Certification	IMO Res. MEPC.107(49)	Test Fluid A	Hydrocarbon Oil Index	2.5
System D - Certification	IMO Res. MEPC.107(49)	Test Fluid A	Hydrocarbon Oil Index	3.5
System D - Certification	IMO Res. MEPC.107(49)	Test Fluid B	Hydrocarbon Oil Index	2.5
System D - Certification	IMO Res. MEPC.107(49)	Test Fluid B	Hydrocarbon Oil Index	2.0
System D - Certification	IMO Res. MEPC.107(49)	Test Fluid B	Hydrocarbon Oil Index	2.0
System D - Certification	IMO Res. MEPC.107(49)	Test Fluid B	Hydrocarbon Oil Index	1.5
System D - Certification	IMO Res. MEPC.107(49)	Test Fluid B	Hydrocarbon Oil Index	1.5
System D - Certification	IMO Res. MEPC.107(49)	Test Fluid B	Hydrocarbon Oil Index	2.5
System D - Certification	IMO Res. MEPC.107(49)	Test Fluid B	Hydrocarbon Oil Index	3.5
System D - Certification	IMO Res. MEPC.107(49)	Test Fluid B	Hydrocarbon Oil Index	3.0
System D - Certification	IMO Res. MEPC.107(49)	Test Fluid B	Hydrocarbon Oil Index	2.5
System D - Certification	IMO Res. MEPC.107(49)	Test Fluid B	Hydrocarbon Oil Index	3.5
System D - Certification	IMO Res. MEPC.107(49)	Test Fluid B	Hydrocarbon Oil Index	3.0
System D - Certification	IMO Res. MEPC.107(49)	Test Fluid B	Hydrocarbon Oil Index	2.5
System D - Certification	IMO Res. MEPC.107(49)	Test Fluid B	Hydrocarbon Oil Index	3.5
System D - Certification	IMO Res. MEPC.107(49)	Test Fluid B	Hydrocarbon Oil Index	3.0
System D - Certification	IMO Res. MEPC.107(49)	Test Fluid B	Hydrocarbon Oil Index	2.5
System D - Certification	IMO Res. MEPC.107(49)	Test Fluid B	Hydrocarbon Oil Index	2.5
System D - Certification	IMO Res. MEPC.107(49)	Test Fluid C	Hydrocarbon Oil Index	1.5
System D - Certification	IMO Res. MEPC.107(49)	Test Fluid C	Hydrocarbon Oil Index	1.5
System D - Certification	IMO Res. MEPC.107(49)	Test Fluid C	Hydrocarbon Oil Index	1.5
System D - Certification	IMO Res. MEPC.107(49)	Test Fluid C	Hydrocarbon Oil Index	2.5
System D - Certification	IMO Res. MEPC.107(49)	Test Fluid C	Hydrocarbon Oil Index	1.5
System D - Certification	IMO Res. MEPC.107(49)	Test Fluid C	Hydrocarbon Oil Index	2.0
System C - Certification	Case Study Specific	Unknown	Oil and grease	<1
System B - OCM Reading	Operational Reading	Process Water	Oil in water concentration	6
System B - OCM Reading	Operational Reading	Process Water	Oil in water concentration	0
System B - OCM Reading	Operational Reading	Process Water	Oil in water concentration	1
System B - OCM Reading	Operational Reading	Process Water	Oil in water concentration	0
System B - OCM Reading	Operational Reading	Process Water	Oil in water concentration	0
System B - OCM Reading	Operational Reading	Process Water	Oil in water concentration	0
System B - OCM Reading	Operational Reading	Process Water	Oil in water concentration	8
System B - OCM Reading	Operational Reading	Process Water	Oil in water concentration	6

System & Data Type	Testing Type	Test Fluid	Analyte	Effluent Result (ppm)
System B - OCM Reading	Operational Reading	Process Water	Oil in water concentration	0
System B - OCM Reading	Operational Reading	Process Water	Oil in water concentration	0
System B - OCM Reading	Operational Reading	Process Water	Oil in water concentration	3
System B - OCM Reading	Operational Reading	Process Water	Oil in water concentration	8
System E - Certification	IMO Res. MEPC.107(49)	Test Fluid A	Hydrocarbon Oil Index	7.1
System E - Certification	IMO Res. MEPC.107(49)	Test Fluid A	Hydrocarbon Oil Index	5.7
System E - Certification	IMO Res. MEPC.107(49)	Test Fluid A	Hydrocarbon Oil Index	5.7
System E - Certification	IMO Res. MEPC.107(49)	Test Fluid A	Hydrocarbon Oil Index	12
System E - Certification	IMO Res. MEPC.107(49)	Test Fluid A	Hydrocarbon Oil Index	10.9
System E - Certification	IMO Res. MEPC.107(49)	Test Fluid A	Hydrocarbon Oil Index	14.7
System E - Certification	IMO Res. MEPC.107(49)	Test Fluid A	Hydrocarbon Oil Index	3.2
System E - Certification	IMO Res. MEPC.107(49)	Test Fluid A	Hydrocarbon Oil Index	12.5
System E - Certification	IMO Res. MEPC.107(49)	Test Fluid B	Hydrocarbon Oil Index	1.7
System E - Certification	IMO Res. MEPC.107(49)	Test Fluid B	Hydrocarbon Oil Index	1.4
System E - Certification	IMO Res. MEPC.107(49)	Test Fluid B	Hydrocarbon Oil Index	2.3
System E - Certification	IMO Res. MEPC.107(49)	Test Fluid B	Hydrocarbon Oil Index	1.6
System E - Certification	IMO Res. MEPC.107(49)	Test Fluid C	Hydrocarbon Oil Index	9.2
System E - Certification	IMO Res. MEPC.107(49)	Test Fluid C	Hydrocarbon Oil Index	8.4
System E - Certification	IMO Res. MEPC.107(49)	Test Fluid C	Hydrocarbon Oil Index	11
System F - Certification	IMO Res. MEPC.107(49)	Test Fluid A	Hydrocarbon Oil Index	<1
System F - Certification	IMO Res. MEPC.107(49)	Test Fluid A	Hydrocarbon Oil Index	<1
System F - Certification	IMO Res. MEPC.107(49)	Test Fluid A	Hydrocarbon Oil Index	<1
System F - Certification	IMO Res. MEPC.107(49)	Test Fluid A	Hydrocarbon Oil Index	<1
System F - Certification	IMO Res. MEPC.107(49)	Test Fluid A	Hydrocarbon Oil Index	<1
System F - Certification	IMO Res. MEPC.107(49)	Test Fluid A	Hydrocarbon Oil Index	<1
System F - Certification	IMO Res. MEPC.107(49)	Test Fluid A	Hydrocarbon Oil Index	<1
System F - Certification	IMO Res. MEPC.107(49)	Test Fluid A	Hydrocarbon Oil Index	<1
System F - Certification	IMO Res. MEPC.107(49)	Test Fluid A	Hydrocarbon Oil Index	<1
System F - Certification	IMO Res. MEPC.107(49)	Test Fluid B	Hydrocarbon Oil Index	<1
System F - Certification	IMO Res. MEPC.107(49)	Test Fluid B	Hydrocarbon Oil Index	<1
System F - Certification	IMO Res. MEPC.107(49)	Test Fluid B	Hydrocarbon Oil Index	<1
System F - Certification	IMO Res. MEPC.107(49)	Test Fluid B	Hydrocarbon Oil Index	<1
System F - Certification	IMO Res. MEPC.107(49)	Test Fluid B	Hydrocarbon Oil Index	<1
System F - Certification	IMO Res. MEPC.107(49)	Test Fluid B	Hydrocarbon Oil Index	<1
System F - Certification	IMO Res. MEPC.107(49)	Test Fluid B	Hydrocarbon Oil Index	<1
System F - Certification	IMO Res. MEPC.107(49)	Test Fluid C	Hydrocarbon Oil Index	<1

System & Data Type	Testing Type	Test Fluid	Analyte	Effluent Result (ppm)
System G - Certification	IMO Res. MEPC.107(49)	Test Fluid C	Hydrocarbon Oil Index	<1
System G - Certification	IMO Res. MEPC.107(49)	Test Fluid C	Hydrocarbon Oil Index	<1
System E - Certification	IMO Res. MEPC.107(49)	unknown	Hydrocarbons	<5
System C - In Service Test	System Start Up Testing	Process Water	Hydrocarbons	<1.0
System C - In Service Test	System Follow up Testing	Process Water	Hydrocarbon Oil Index	<0.1
System D - In Service Test	Case Study Specific	Process Water	Hydrocarbon Concentration	<1
System H - Certification	IMO Res. MEPC.107(49)	Test Fluid A	Oil content	6
System H - Certification	IMO Res. MEPC.107(49)	Test Fluid A	Oil content	6
System H - Certification	IMO Res. MEPC.107(49)	Test Fluid A	Oil content	5
System H - Certification	IMO Res. MEPC.107(49)	Test Fluid A	Oil content	8
System H - Certification	IMO Res. MEPC.107(49)	Test Fluid A	Oil content	6
System H - Certification	IMO Res. MEPC.107(49)	Test Fluid A	Oil content	6
System H - Certification	IMO Res. MEPC.107(49)	Test Fluid A	Oil content	10
System H - Certification	IMO Res. MEPC.107(49)	Test Fluid A	Oil content	6
System H - Certification	IMO Res. MEPC.107(49)	Test Fluid A	Oil content	6
System H - Certification	IMO Res. MEPC.107(49)	Test Fluid B	Oil content	8
System H - Certification	IMO Res. MEPC.107(49)	Test Fluid B	Oil content	8
System H - Certification	IMO Res. MEPC.107(49)	Test Fluid B	Oil content	9
System H - Certification	IMO Res. MEPC.107(49)	Test Fluid B	Oil content	8
System H - Certification	IMO Res. MEPC.107(49)	Test Fluid B	Oil content	8
System H - Certification	IMO Res. MEPC.107(49)	Test Fluid B	Oil content	8
System H - Certification	IMO Res. MEPC.107(49)	Test Fluid C	Oil content	9
System H - Certification	IMO Res. MEPC.107(49)	Test Fluid C	Oil content	10
System H - Certification	IMO Res. MEPC.107(49)	Test Fluid C	Oil content	6
System H - Certification	IMO Res. MEPC.107(49)	Test Fluid A	Oil content	6
System H - Certification	IMO Res. MEPC.107(49)	Test Fluid A	Oil content	6
System H - Certification	IMO Res. MEPC.107(49)	Test Fluid A	Oil content	5
System H - Certification	IMO Res. MEPC.107(49)	Test Fluid A	Oil content	8
System H - Certification	IMO Res. MEPC.107(49)	Test Fluid A	Oil content	6
System H - Certification	IMO Res. MEPC.107(49)	Test Fluid A	Oil content	6
System H - Certification	IMO Res. MEPC.107(49)	Test Fluid A	Oil content	10
System H - Certification	IMO Res. MEPC.107(49)	Test Fluid A	Oil content	6
System H - Certification	IMO Res. MEPC.107(49)	Test Fluid A	Oil content	6
System H - Certification	IMO Res. MEPC.107(49)	Test Fluid B	Oil content	8
System H - Certification	IMO Res. MEPC.107(49)	Test Fluid B	Oil content	8
System H - Certification	IMO Res. MEPC.107(49)	Test Fluid B	Oil content	9

System & Data Type	Testing Type	Test Fluid	Analyte	Effluent Result (ppm)
System H - Certification	IMO Res. MEPC.107(49)	Test Fluid B	Oil content	6
System H - Certification	IMO Res. MEPC.107(49)	Test Fluid B	Oil content	5
System H - Certification	IMO Res. MEPC.107(49)	Test Fluid B	Oil content	5
System H - Certification	IMO Res. MEPC.107(49)	Test Fluid C	Oil content	5
System H - Certification	IMO Res. MEPC.107(49)	Test Fluid C	Oil content	5
System H - Certification	IMO Res. MEPC.107(49)	Test Fluid C	Oil content	5
System I - Certification	IMO Res. MEPC.107(49)	Test Fluid A	Hydrocarbon Oil Index	0.21
System I - Certification	IMO Res. MEPC.107(49)	Test Fluid A	Hydrocarbon Oil Index	<0.1
System I - Certification	IMO Res. MEPC.107(49)	Test Fluid A	Hydrocarbon Oil Index	<0.1
System I - Certification	IMO Res. MEPC.107(49)	Test Fluid A	Hydrocarbon Oil Index	0.13
System I - Certification	IMO Res. MEPC.107(49)	Test Fluid A	Hydrocarbon Oil Index	0.17
System I - Certification	IMO Res. MEPC.107(49)	Test Fluid A	Hydrocarbon Oil Index	0.12
System I - Certification	IMO Res. MEPC.107(49)	Test Fluid A	Hydrocarbon Oil Index	0.26
System I - Certification	IMO Res. MEPC.107(49)	Test Fluid A	Hydrocarbon Oil Index	0.17
System I - Certification	IMO Res. MEPC.107(49)	Test Fluid A	Hydrocarbon Oil Index	0.18
System I - Certification	IMO Res. MEPC.107(49)	Test Fluid B	Hydrocarbon Oil Index	0.1
System I - Certification	IMO Res. MEPC.107(49)	Test Fluid B	Hydrocarbon Oil Index	0.26
System I - Certification	IMO Res. MEPC.107(49)	Test Fluid B	Hydrocarbon Oil Index	0.35
System I - Certification	IMO Res. MEPC.107(49)	Test Fluid B	Hydrocarbon Oil Index	<0.1
System I - Certification	IMO Res. MEPC.107(49)	Test Fluid B	Hydrocarbon Oil Index	0.14
System I - Certification	IMO Res. MEPC.107(49)	Test Fluid B	Hydrocarbon Oil Index	0.13
System I - Certification	IMO Res. MEPC.107(49)	Test Fluid C	Hydrocarbon Oil Index	0.15
System I - Certification	IMO Res. MEPC.107(49)	Test Fluid C	Hydrocarbon Oil Index	0.42
System I - Certification	IMO Res. MEPC.107(49)	Test Fluid C	Hydrocarbon Oil Index	0.1
System J - Certification	IMO Res. MEPC.107(49)	Test Fluid A	Hydrocarbon Oil Index	0.14
System J - Certification	IMO Res. MEPC.107(49)	Test Fluid A	Hydrocarbon Oil Index	0.11
System J - Certification	IMO Res. MEPC.107(49)	Test Fluid A	Hydrocarbon Oil Index	<0.1
System J - Certification	IMO Res. MEPC.107(49)	Test Fluid A	Hydrocarbon Oil Index	0.21
System J - Certification	IMO Res. MEPC.107(49)	Test Fluid A	Hydrocarbon Oil Index	0.19
System J - Certification	IMO Res. MEPC.107(49)	Test Fluid A	Hydrocarbon Oil Index	0.15
System J - Certification	IMO Res. MEPC.107(49)	Test Fluid A	Hydrocarbon Oil Index	0.2
System J - Certification	IMO Res. MEPC.107(49)	Test Fluid A	Hydrocarbon Oil Index	0.92
System J - Certification	IMO Res. MEPC.107(49)	Test Fluid A	Hydrocarbon Oil Index	1.14
System J - Certification	IMO Res. MEPC.107(49)	Test Fluid B	Hydrocarbon Oil Index	0.63
System J - Certification	IMO Res. MEPC.107(49)	Test Fluid B	Hydrocarbon Oil Index	0.44
System J - Certification	IMO Res. MEPC.107(49)	Test Fluid B	Hydrocarbon Oil Index	0.51

System & Data Type	Testing Type	Test Fluid	Analyte	Effluent Result (ppm)
System J - Certification	IMO Res. MEPC.107(49)	Test Fluid B	Hydrocarbon Oil Index	0.17
System J - Certification	IMO Res. MEPC.107(49)	Test Fluid B	Hydrocarbon Oil Index	<0.1
System J - Certification	IMO Res. MEPC.107(49)	Test Fluid B	Hydrocarbon Oil Index	2.2
System J - Certification	IMO Res. MEPC.107(49)	Test Fluid C	Hydrocarbon Oil Index	3.4
System J - Certification	IMO Res. MEPC.107(49)	Test Fluid C	Hydrocarbon Oil Index	4.1
System J - Certification	IMO Res. MEPC.107(49)	Test Fluid C	Hydrocarbon Oil Index	4.7
System M - Certification	IMO Res. MEPC.107(49)	Test Fluid A	Hydrocarbon Oil Index	0.2
System M - Certification	IMO Res. MEPC.107(49)	Test Fluid A	Hydrocarbon Oil Index	0.2
System M - Certification	IMO Res. MEPC.107(49)	Test Fluid A	Hydrocarbon Oil Index	0.11
System M - Certification	IMO Res. MEPC.107(49)	Test Fluid A	Hydrocarbon Oil Index	0.21
System M - Certification	IMO Res. MEPC.107(49)	Test Fluid A	Hydrocarbon Oil Index	0.14
System M - Certification	IMO Res. MEPC.107(49)	Test Fluid A	Hydrocarbon Oil Index	<0.1
System M - Certification	IMO Res. MEPC.107(49)	Test Fluid A	Hydrocarbon Oil Index	<0.1
System M - Certification	IMO Res. MEPC.107(49)	Test Fluid A	Hydrocarbon Oil Index	0.2
System M - Certification	IMO Res. MEPC.107(49)	Test Fluid A	Hydrocarbon Oil Index	0.38
System M - Certification	IMO Res. MEPC.107(49)	Test Fluid B	Hydrocarbon Oil Index	<0.1
System M - Certification	IMO Res. MEPC.107(49)	Test Fluid B	Hydrocarbon Oil Index	0.24
System M - Certification	IMO Res. MEPC.107(49)	Test Fluid B	Hydrocarbon Oil Index	0.15
System M - Certification	IMO Res. MEPC.107(49)	Test Fluid B	Hydrocarbon Oil Index	0.2
System M - Certification	IMO Res. MEPC.107(49)	Test Fluid B	Hydrocarbon Oil Index	0.34
System M - Certification	IMO Res. MEPC.107(49)	Test Fluid B	Hydrocarbon Oil Index	0.16
System M - Certification	IMO Res. MEPC.107(49)	Test Fluid C	Hydrocarbon Oil Index	0.4
System M - Certification	IMO Res. MEPC.107(49)	Test Fluid C	Hydrocarbon Oil Index	1
System M - Certification	IMO Res. MEPC.107(49)	Test Fluid C	Hydrocarbon Oil Index	1.1
System K - Certification	IMO Res. MEPC.107(49)	Test Fluid A	Hydrocarbon Oil Index	0.1
System K - Certification	IMO Res. MEPC.107(49)	Test Fluid A	Hydrocarbon Oil Index	0.1
System K - Certification	IMO Res. MEPC.107(49)	Test Fluid A	Hydrocarbon Oil Index	<0.1
System K - Certification	IMO Res. MEPC.107(49)	Test Fluid A	Hydrocarbon Oil Index	0.1
System K - Certification	IMO Res. MEPC.107(49)	Test Fluid A	Hydrocarbon Oil Index	<0.1
System K - Certification	IMO Res. MEPC.107(49)	Test Fluid A	Hydrocarbon Oil Index	<0.1
System K - Certification	IMO Res. MEPC.107(49)	Test Fluid A	Hydrocarbon Oil Index	<0.1
System K - Certification	IMO Res. MEPC.107(49)	Test Fluid A	Hydrocarbon Oil Index	<0.1
System K - Certification	IMO Res. MEPC.107(49)	Test Fluid A	Hydrocarbon Oil Index	<0.1
System K - Certification	IMO Res. MEPC.107(49)	Test Fluid B	Hydrocarbon Oil Index	<0.1
System K - Certification	IMO Res. MEPC.107(49)	Test Fluid B	Hydrocarbon Oil Index	0.1
System K - Certification	IMO Res. MEPC.107(49)	Test Fluid B	Hydrocarbon Oil Index	<0.1

System & Data Type	Testing Type	Test Fluid	Analyte	Effluent Result (ppm)
System K - Certification	IMO Res. MEPC.107(49)	Test Fluid B	Hydrocarbon Oil Index	<0.1
System K - Certification	IMO Res. MEPC.107(49)	Test Fluid B	Hydrocarbon Oil Index	<0.1
System K - Certification	IMO Res. MEPC.107(49)	Test Fluid B	Hydrocarbon Oil Index	<0.1
System K - Certification	IMO Res. MEPC.107(49)	Test Fluid C	Hydrocarbon Oil Index	<0.1
System K - Certification	IMO Res. MEPC.107(49)	Test Fluid C	Hydrocarbon Oil Index	<0.1
System K - Certification	IMO Res. MEPC.107(49)	Test Fluid C	Hydrocarbon Oil Index	<0.1
System L - Certification	IMO Res. MEPC.107(49)	Test Fluid A	Oil content	1.25
System L - Certification	IMO Res. MEPC.107(49)	Test Fluid A	Oil content	1.52
System L - Certification	IMO Res. MEPC.107(49)	Test Fluid A	Oil content	0.88
System L - Certification	IMO Res. MEPC.107(49)	Test Fluid A	Oil content	1.35
System L - Certification	IMO Res. MEPC.107(49)	Test Fluid A	Oil content	0.51
System L - Certification	IMO Res. MEPC.107(49)	Test Fluid B	Oil content	5.3
System L - Certification	IMO Res. MEPC.107(49)	Test Fluid B	Oil content	4.1
System L - Certification	IMO Res. MEPC.107(49)	Test Fluid B	Oil content	4.1
System L - Certification	IMO Res. MEPC.107(49)	Test Fluid B	Oil content	1.2
System L - Certification	IMO Res. MEPC.107(49)	Test Fluid B	Oil content	1.1
System L - Certification	IMO Res. MEPC.107(49)	Test Fluid C	Oil content	2.7
System L - Certification	IMO Res. MEPC.107(49)	Test Fluid C	Oil content	2.2
System L - Certification	IMO Res. MEPC.107(49)	Test Fluid C	Oil content	1.6
System L - Certification	IMO Res. MEPC.107(49)	Test Fluid C	Oil content	1.5
System L - Certification	IMO Res. MEPC.107(49)	Test Fluid C	Oil content	0.72